

智慧箱泵集成供水行业引领者

 铭星供水设备
MINGXING WATER SUPPLY



WQ / WQW / WQWF

Submersible Pump

50Hz



Jiangsu Mingxing water supply equipment Co., Ltd

Address: No. 1, Mingxing North Road, Tech Innovation Park, Jianhu, Yancheng City, Jiangsu, China
National free service hotline: 400-6767-228 Consultation hotline: 0515-80663333
After sales hotline: 0515-80685356 Fax: 0515-86272222
Website: www.mxgs.cn/ www.xinxingjs.com
Postal code: 224700 E-MAIL: xinxing@xinxingjs.com

Scan and learn more Mar. 2024 Edition

江苏铭星供水设备有限公司
JIANGSU MINGXING WATER SUPPLY EQUIPMENT CO.,LTD

CONTENTS

1	Overview
5	WQW-2P/WQWF-2P Premium model
11	WQW-4P Premium model
16	WQ/WQF Standard model



COMPANY PROFILE

About Us

The company is product-oriented and has established long-term industry-university-research cooperation relationships with national key scientific research institutes. It has a provincial R&D platform, and has dozens of intellectual property rights such as invention patents, utility model patents, and copyrights. Many products such as floating pump station have been rated as provincial high-tech products and provincial new product and new technology appraisal. Editor-in-chief of "Selection and Installation of Prefabricated Tank Pump Integrated Fire Water Supply Pump Station - MX Smart Pump Station" 18CS01, "Technical Regulations of Prefabricated Tank Pump Integrated Fire Water Supply Pump Station" CECS623-2019, and participated in the compilation of "Inverter Frequency Modulation Selection and Installation of Quick Water Supply Equipment" 16S111, "Technical Regulations for the Application of Sewage Lifting Devices" CECS463-2017, "Practical Guidelines for Water Disposal Regulations" and other atlases, standards and technical documents.

Since its establishment in 2006, the company has unwaveringly adhered to product innovation, and has a broad customer base in government departments, hospitals, education and other fields.

The company has passed the three major certifications of ISO9001 quality management system, ISO14000 environmental management system and OHSAS occupational health and safety system. Fire protection products have passed 3C compulsory certification, established a perfect quality assurance system, and was rated as "AAA-level" credit unit in Jiangsu Province.

As a standard-setting enterprise for intelligent fire protection integrated pumping station, the company has an independent and mature software and hardware development team, independent research and development and production capacity is quite large, which has laid a solid foundation and strong guarantee for the intelligent fire protection industry.

The company's latest "smart fire protection" system, based on the design concept of smart city construction, applies a new generation of information technologies such as the Internet of Things, big data, cloud computing, mobile Internet, etc., which can fully realize the efficient operation of the fire alarm system and effectively improve the entire fire protection system. The efficiency of linkage and cooperation of the system truly achieves the perfect embodiment of prevention first and the combination of prevention and fire protection advocated by fire protection.

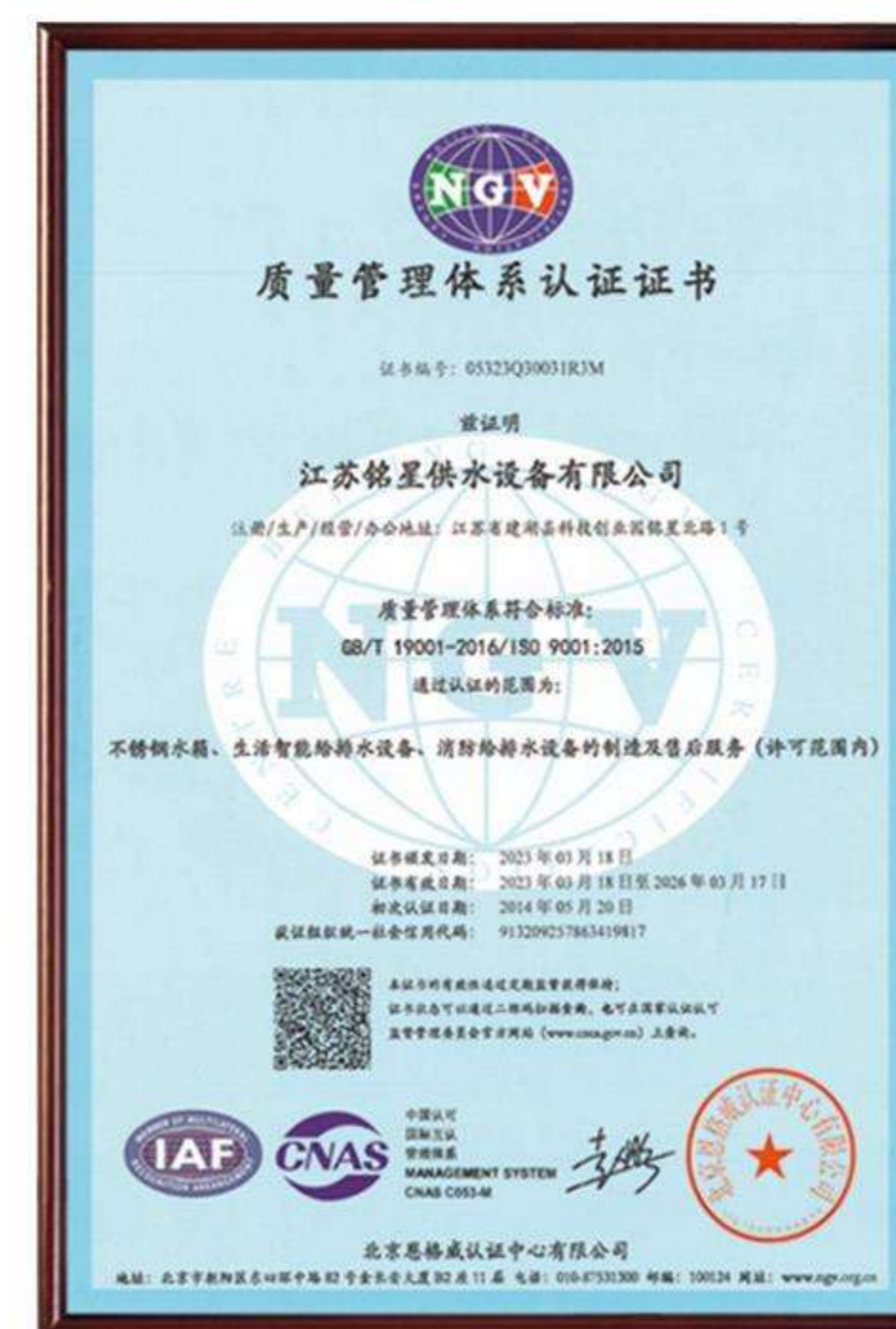

一、Product overview

The newly launched submersible sewage pump is developed by screening and improving similar WQ series products at home and abroad to overcome their shortcomings. Rational optimization and innovative design are carried out in hydraulic model, sealing technology, mechanical structure, protection and control, etc., making it more reliable, safe, lightweight and practical, long life and good sewage performance; The whole series of products, the type spectrum is reasonable, easy to select. It is equipped with special electric control cabinet for submersible pump to realize its protection and automatic control.

Model screening: Performance optimization, two-channel impeller, reasonable arrangement of two to three mechanical seals, so that the mechanical seal lubrication, cooling more ideal, smooth operation without plugging, good flow capacity.

Seal improvement: With series mechanical seals, shaft seals are more reliable and have longer service life.

Structural optimization: The structural design is conducive to the sealing of the machine seal, smooth operation, vibration resistance, drop resistance, higher reliability; Optimized design, sewage pump more portable and practical, more corrosion resistance, wear resistance.

IPX8 motor protection grade, submersible motor cooling effect is good, the temperature rise is lower than the ordinary motor, the durability is further improved, F class insulation to promote the motor longer service life.

The motor is equipped with a variety of protection devices, which can facilitate the user to optimize the selection

二、Main applications

Suitable for building buildings, hospitals, residential areas, municipal engineering, road traffic and its construction, engineering sewage, small sewage treatment and other occasions to discharge wastewater containing solid particles, long fibers, rainwater, sewage.

三、Conditions of use

- 1、Power supply 380V, three-phase, 50Hz.
- 2、the medium temperature generally does not exceed 40°C, PH value 4-10, medium weight $\leq 1100\text{kg/m}^3$.
- 3、The lowest liquid level complies with the lowest liquid level mark H1 in the installation dimension drawing.
- 4、can not adapt to strong corrosive fluid and strong abrasive solid particles of the medium.
- 5、the diameter of the solid object in the medium is not greater than the maximum solid diameter allowed through.
- 6、altitude ≤ 2000 meters;
- 7、the environment has no explosive danger of the medium, no enough to corrode metal and destroy the insulation of the damp gas and dust, the average maximum monthly humidity $\leq 90\%$ (25°C)
- 8、vertical installation inclination $\leq 5^\circ$.

四、Structure specifications

1、Impeller of pump body

Carefully selected and matched pump body and impeller, so that the flow channel through the performance is good, high efficiency, flat power curve, not easy to overload. The impeller has precise balance, small vibration and smooth rotation.

2、Motor

Specially designed submersible motor, IPX8 protection, F class insulation allows high temperature rise, under normal temperature rise conditions, the motor insulation life is extended, and the submersible cooling effect is good, the actual temperature rise is low, the motor insulation life is longer.

3、Motor Cooling

The heat of the motor is dissipated through the housing, and the medium can operate reliably and safely as long as it penetrates half of the stator housing of the motor, the more it penetrates, the more favorable the motor cooling.

4、Shaft seal

The motor shaft seal adopts two to three series of mechanical seals to form a multi-channel reliable sealing line. One is in the medium in the pump, the sealing surface is pressed more tightly with the increase of the pressure of the medium, effectively preventing water from entering the oil chamber, and the other two are in the oil chamber to prevent oil from entering the motor, if the first one fails, the other two can still prevent oil and water from entering the motor. The bellows type seal and the innovative structural cavity further improve the reliability of the shaft seal, and the trouble-free running time exceeds 9000h under normal use.

5、Oil chamber

The oil chamber is filled with suitable mechanical oil and installed with two mechanical seals. The oil chamber is a barrier to prevent the medium from entering the motor from the pump shaft and prevent the medium from penetrating into the motor. If the first seal leaks, the buffer medium from the oil chamber cannot directly enter the motor. At the same time, the two independent sealing friction surfaces are lubricated and cooled to make the sealing work more reliable. In addition, it can also take away the heat of the lower bearing and some heat of the motor.

6、Bearing

The lower bearing constitutes the reliable support of the motor pump shaft. The lower bearing can be composed of two or three different bearing types according to the radial and axial forces and pulsating loads generated during the operation of the sewage pump. Ensure smooth operation and long service life of the unit.

7、Cable and seal

- 1) The cable is a flexible cable and cable core section designed for long-term reliable operation according to the ambient temperature of 40°C and the full load power of the motor. If the sewage pump is working, the motor will have a longer service life under the non-full load power or under the environment of 40°C .
- 2) There is a seal between the rubber sleeve of the cable edge and the motor pressure to prevent the medium from penetrating into the motor cavity between the cable and the motor cover interface.
- 3) There is rubber vulcanization between the cable sleeve and the core, once the rubber jacket is scratched, it can still effectively prevent the medium from entering the motor from the cable sheath.

8、Motor shell

The frame, bearing seat, cover, etc. constitute the motor shell, and the parts are connected with a reliable static seal, each of which is checked by strict hydraulic test to ensure its water tightness.

9、Safety protection in the pump (functions through a special electric control cabinet)

- 1) Oil and water probe: installed in the oil chamber to detect the leakage of the first seal (in the medium), when the leaking medium reaches the oil chamber, an alarm signal is generated.
- 2) Water inlet probe: installed in the motor cavity to detect the leakage of the second machine seal. When the oil (oil-water mixture) enters the motor, the water inlet probe will send an alarm signal and stop the pump.
- 3) Thermal element: installed in the motor stator winding, if the electric length is overloaded, the motor winding temperature (or other reasons for motor winding heat) reaches a certain value, send an alarm signal and stop the pump.

10、External control system

The special electric control cabinet can process all kinds of signals in the pump, and realize the functions of control, protection, sound and light alarm and a variety of automatic control of single pump and multi-pump. When the user brings his own electric control cabinet, he should contact the electric control cabinet group of our company to guide the user to install the protection controller in the electric control cabinet.

11、Performance curve and main parameters

The curve on the performance curve shows the recommended range of use of the pump. When the flow medium of the pump changes, it must be noted that the shaft power is within the rated power range of the motor when used, and when it is found that the overload is used, the submersible motor will burn out.

五、Installation mode

WQ series small submersible sewage pump has automatic coupling installation (Z), hard tube movable installation (Y), flexible tube movable e installation (R). Either way, it's easy to install.

WQ type fixed automatic coupling mounting dimensions

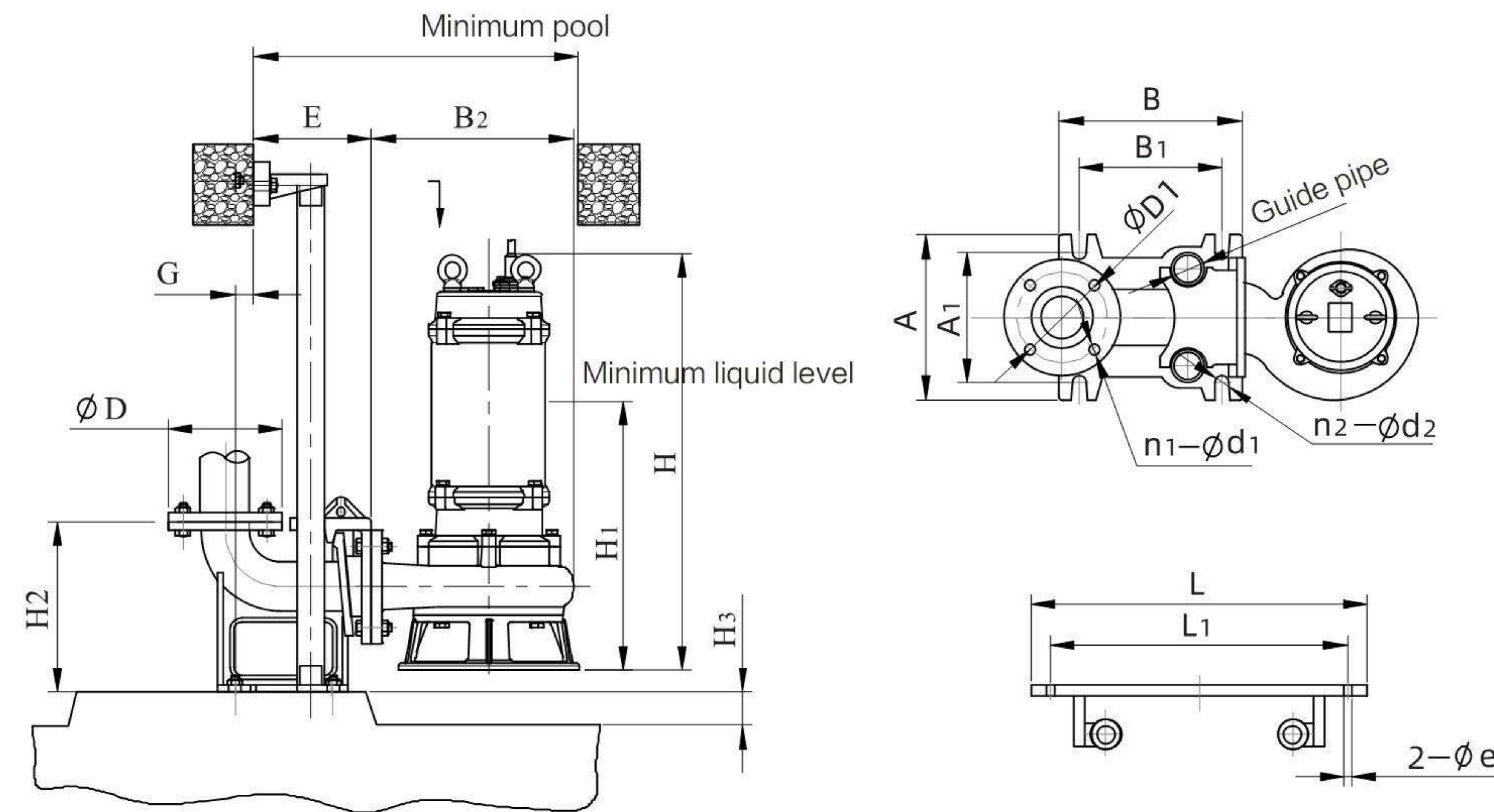

WQ mobile installation dimensions

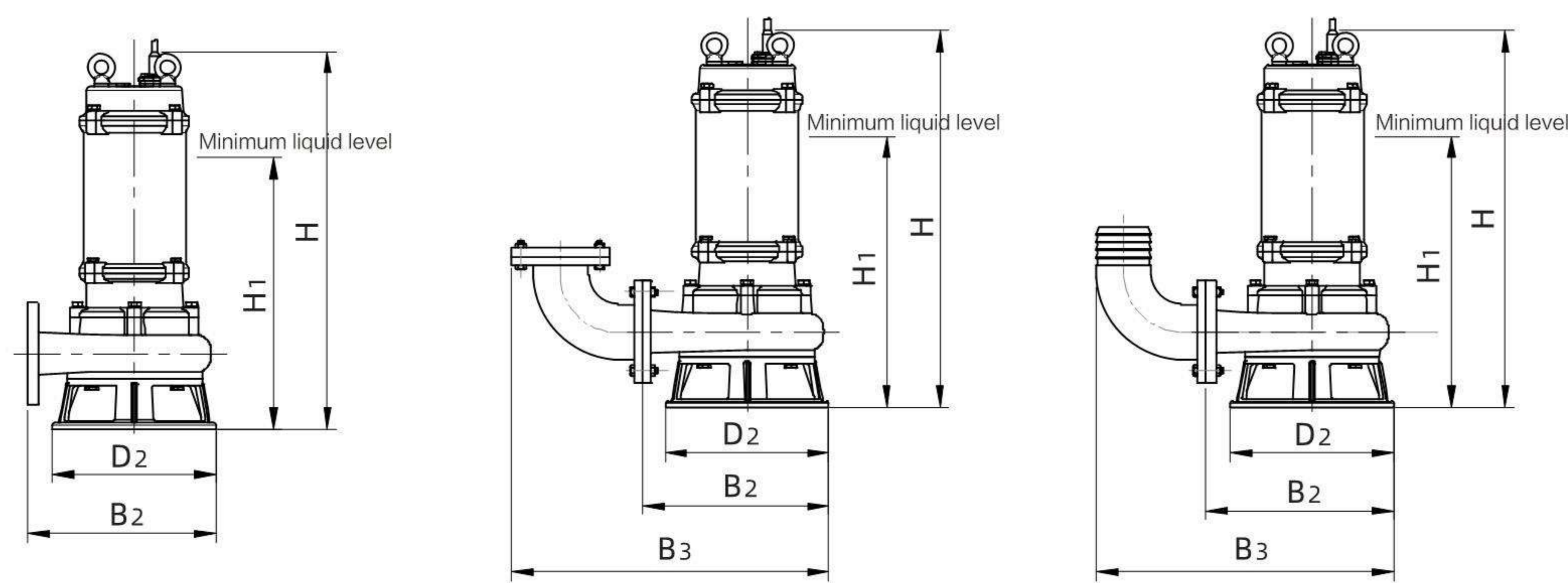

A、Rigid pipe movable installation B、hard pipe (with double head flange bend pipe) movable installation C、flexible hose movable installation

六、WQW, WQWF, WQ, JYWQ series submersible sewage pump coupling installation dimensions

S/N	Model	Flange connection size PN0.6MPa mm			Coupling base dimension mm					G	H ₂	L	L ₁	Guide rod size	φ e	E
		D	D1	N1-φ d1	A	A ₁	B	B ₁	N2-φ d2							
1	DN40	130	100	4-φ 14	108	69	138	69	4-φ 16	2	210	226	186	1	12	147
2	DN50	140	110	4-φ 14	138	120	212	130	4-φ 16	56	210	220	178	1	12	127
3	DN65	160	130	4-φ 14	160	140	203	140	4-φ 16	66	240	230	188	1	12	132
4	DN80	190	150	4-φ 18	180	160	223	160	4-φ 18	76	280	250	204	1.5	12	146
5	DN100	210	170	4-φ 18	220	200	263	200	4-φ 18	116	320	270	224	1.5	12	157
6	DN150	265	225	8-φ 18	360	285	408	300	4-φ 20	128	482	388	250	1.5	12	271
7	DN200	320	280	8-φ 18	397	302	452	350	4-φ 20	168	550	388	250	1.5	16	276

S/N	Model	Flange connection size PN0.6MPa mm			Coupling base dimension mm					G	H ₂	L	L ₁	Guide rod size	φ e	E
		D	D1	N1-φ d1	A	A ₁	B	B ₁	N2-φ d2							
1	DN250	395	350	12-φ 22	460	360	560	430	4-φ 30	242	632	388	250	1.5	16	298
2	DN300	445	400	12-φ 22	550	410	570	410	4-φ 30	235	738	480	305	2	16	334
3	DN350	505	460	16-φ 22	580	420	615	402	4-φ 30	241	858	500	318	2	16	346
4	DN400	565	515	16-φ 26	627	490	680	510	4-φ 40	325	958	500	318	2	16	409
5	DN500	670	620	20-φ 26	732	570	752	550	4-φ 40	361	1158	748	658	2.5	24	369
6	DN600	780	725	20-φ 30	830	720	850	700	4-φ 40	479	1320	830	740	2.5	24	387

七、Main parts of the pump material

components	Pump body, impeller lower cover	Motor housing	shaft	Machine seal friction material	
				Motor side	Body side
Cast iron pump material	HT200/QT600	HT200	45#/20Cr13	Graphite/silicon carbide	Graphite/silicon carbide/tungsten carbide
Stainless steel pump material	304-316L	304-316L	45#/304-316L	Graphite/silicon carbide	Graphite/silicon carbide/tungsten carbide

八、WQW/ WQWF non-clogging cutting sewage pump

1、Appearance pictures (Premium type)



WQW Type

WQWF Type

The pump has the most reasonable cutting structure in the world, which perfectly avoids the blockage of the pump. The pump has a limiting ring to prevent the entanglement of foreign bodies and a rotating impeller with a cutting edge, which is combined with a water inlet base with a fixed knife ring to form a powerful cutting function. When the impeller rotates, the edge of the blade moves in reverse with the water inlet of the knife ring, which has an efficient cutting function. The impeller and water inlet base are made of casting processing, which can improve the flow, head and efficiency of the cutting pump.

2、Pump definition

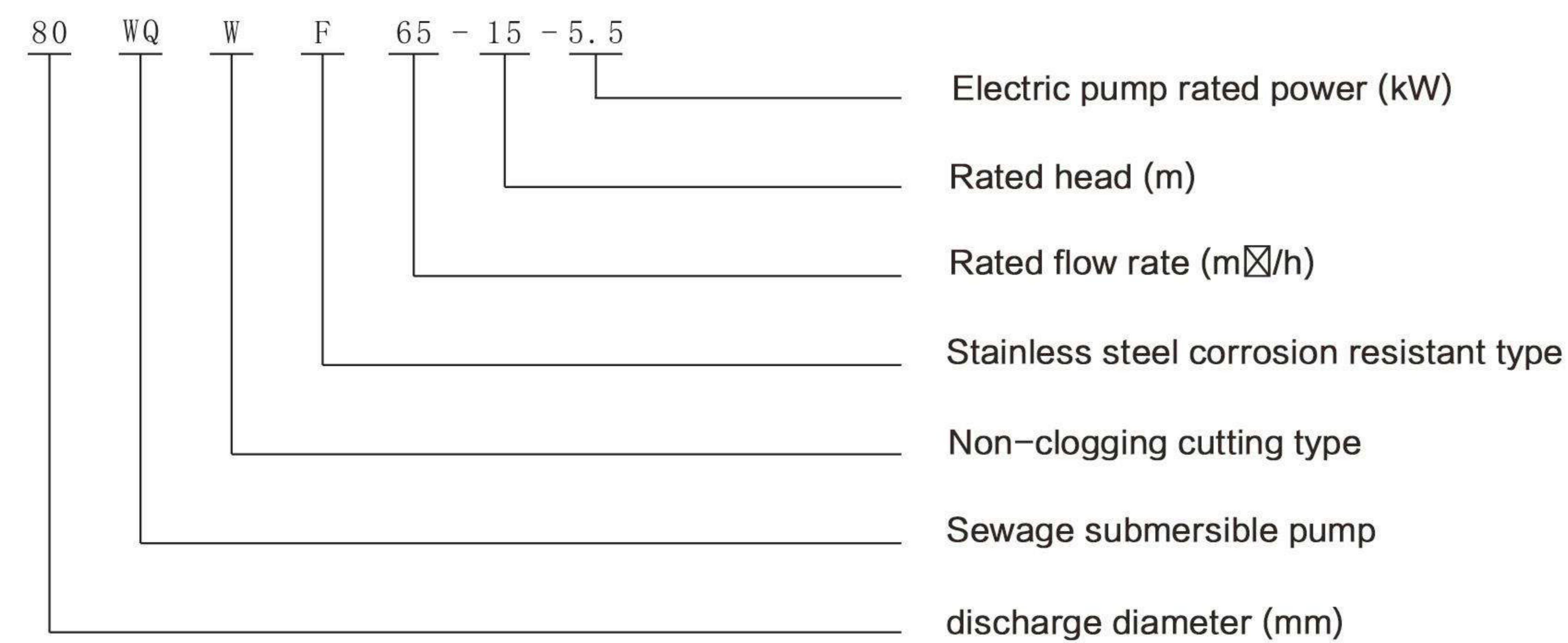

九、Two pole motor structure diagram

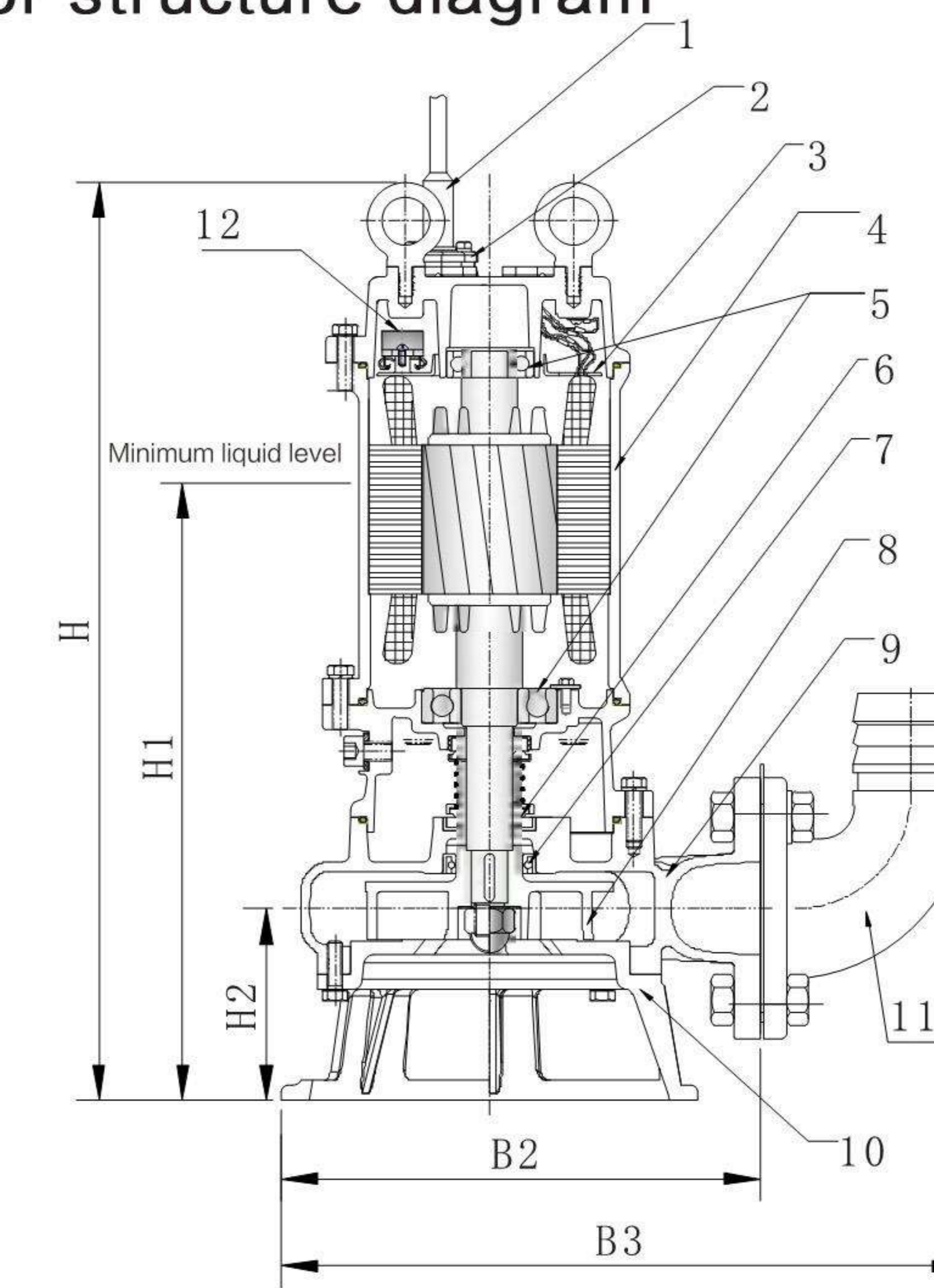

1、WQW cast iron pump structure specification

S/N	Components	Material	S/N	Components	Material
1	Cable	YZW	7	Skeleton oil seal	Nitrile rubber
2	Cable gland	304	8	Impeller	QT600
3	Cable board	PA66	9	Pump Body	HT200
4	Motor	Shell HT200	10	Base	QT600
5	Bearing	Standard part	11	Flange pipe (optional)	HT200
6	M/S	Graphite/silicon carbide/ tungsten carbide	12	Thermal protector	/

2、WQWF stainless steel pump structure specification

S/N	Components	Material	S/N	Components	Material
1	Cable	YZW	7	Skeleton oil seal	Nitrile rubber
2	Cable gland	Stainless steel 304-316L	8	Impeller	Stainless steel 304-316L
3	Cable board	PA66	9	Casing	Stainless steel 304-316L
4	Motor	Housing SS304-316L	10	Base	Stainless steel 304-316L
5	Bearing	Standard part	11	Flange elbow(optional)	Stainless steel 304-316L
6	Mechanical seal	Graphite/silicon carbide/tungsten carbide	12	Thermal protector	/

十、Technical parameters and dimensions (2-pole motor)

1、WQW cast iron without plugging cutting sewage submersible pump data (WQWF stainless steel type same parameters)

Model	Dia	Q	H	RPM	power	Current	Maximum diameter of particles passed	weight	Overall dimension (mm)				
	mm	m ³ /h	m	rpm	kW	A	mm	kg	H	H1	H2	B2	B3
40WQW10-10-0.75	40	10	10	2900	0.75	1.8	20	23	400	300	93	217	312
40WQW10-15-1.1	40	10	15	2900	1.1	2.6	20	27	415	315	93	217	312
50WQW10-10-0.75	50	10	10	2900	0.75	1.8	20	23	400	300	93	217	312
50WQW10-15-1.1	50	10	15	2900	1.1	2.6	20	27	415	315	93	217	312
50WQW15-10-1.1	50	15	10	2900	1.1	2.6	20	27	415	315	93	217	312
50WQW15-15-1.5	50	15	15	2900	1.5	3.3	26	35	493	370	103	250	345
50WQW9-22-2.2	50	9	22	2900	2.2	4.6	26	39	518	390	103	250	345
50WQW15-20-2.2	50	15	20	2900	2.2	4.6	26	39	518	390	103	250	345
50WQW15-25-3	50	15	25	2900	3	6.1	23	47	535	405	120	291	386
50WQW15-32-4	50	15	32	2900	4	7.7	18	52	565	435	120	291	386
50WQW25-25-4	50	25	25	2900	4	7.7	23	52	565	435	120	291	386
50WQW15-40-5.5	50	15	40	2900	5.5	10.8	18	86	650	510	123	313	408
50WQW20-45-7.5	50	20	45	2900	7.5	14.3	18	86	690	550	123	313	408
50WQW20-55-11	50	20	55	2900	11	21.8	19	100	765	480	128	346	441
50WQW20-60-15	50	20	60	2900	15	29.3	19	116	805	520	128	346	441
65WQW15-7-0.75	65	15	7	2900	0.75	1.8	20	23	400	300	93	217	312
65WQW15-10-1.1	65	15	10	2900	1.1	2.6	20	29	415	315	93	217	312
65WQW25-10-1.5	65	25	10	2900	1.5	3.3	26	38	493	370	103	250	355
65WQW25-14-2.2	65	25	14	2900	2.2	4.6	26	42	518	390	103	250	355
65WQW25-18-3	65	25	18	2900	3	6.1	26	48	535	405	120	291	396
65WQW40-16-4	65	40	16	2900	4	7.7	26	67	565	435	120	291	396
65WQW30-25-5.5	65	30	25	2900	5.5	10.8	18	87	650	510	123	313	418
65WQW30-35-7.5	65	30	35	2900	7.5	14.3	18	87	690	550	123	313	418
65WQW40-45-11	65	40	45	2900	11	21.8	19	122	765	480	128	346	441
65WQW40-50-15	65	40	50	2900	15	29.3	19	130	805	520	128	346	441
80WQW35-7-1.5	80	35	7	2900	1.5	3.3	45	51	505	390	107	276	401
80WQW40-8-2.2	80	40	8	2900	2.2	4.6	45	55	530	415	107	276	401
80WQW35-13-3	80	35	13	2900	3	6.1	45	49	560	430	130	295	420
80WQW50-12-4	80	50	12	2900	4	7.7	45	43	590	460	130	295	420
80WQW40-22-5.5	80	40	22	2900	5.5	10.8	26	87	660	520	125	325	450
80WQW40-30-7.5	80	40	30	2900	7.5	14.3	26	87	700	560	125	325	450
80WQW60-35-11	80	60	35	2900	11	21.8	32	122	775	490	136	340	490
80WQW60-40-15	80	60	40	2900	15	29.3	32	130	815	530	136	340	490
100WQW50-10-3	100	50	10	2900	3	6.1	55	50	578	458	136	306	456
100WQW60-11-4	100	60	11	2900	4	7.7	55	55	608	488	136	306	456
100WQW65-15-5.5	100	65	15	2900	5.5	10.8	46	92	690	550	143	320	470
100WQW65-20-7.5	100	65	20	2900	7.5	14.3	46	100	730	590	143	320	470
100WQW80-25-11	100	80	25	2900	11	21.8	25	125	775	490	136	340	490
100WQW100-30-15	100	100	30	2900	15	29.3	25	133	815	530	136	340	490
150WQW100-10-5.5	150	100	10	2900	5.5	10.8	60	112	707	567	150	356	556
150WQW140-10-7.5	150	140	10	2900	7.5	14.3	60	120	747	607	150	356	556
150WQW140-15-11	150	140	15	2900	11	21.8	55	128	805	520	168	398	598
150WQW150-20-15	150	150	20	2900	15	29.3	55	136	845	560	168	398	598
200WQW180-10-11	200	180	10	2900	11	21.8	70	132	835	550	199	413	670
200WQW180-15-15	200	180	15	2900	15	29.3	70	140	875	590	199	413	670

Note: WQWF stainless steel type no 40 discharge model

2、WQW cast iron without plugging cutting sewage submersible pump performance data (WQWF stainless steel type same parameters)

Model	Q(m ³ /h)	5	10	15	20	25	30	35	40	45	50	55	
40WQW10-10-0.75	H (m)	11.5	10	8	6								
40WQW10-15-1.1		17	15	12.7	9	4							
40WQW15-10-1.1		14.5	12	10	7.5	4.8							
50WQW10-10-0.75		11.5	10	8	6								
50WQW10-15-1.1		17	15	12.7	9	4							
50WQW15-10-1.1		14.5	12	10	7.5	4.8							
50WQW15-15-1.5		18	16.5	15	13.3	11.5	9						
50WQW15-20-2.2		23.3	21.8	20	18.2	16.3	14.2	12.7					
50WQW15-25-3		28.5	27	25	23.2	21.3	19.3	17					
50WQW15-32-4		36	34	32	30	28	26.5	23.6	21				
50WQW25-25-4		31	29.8	28.4	26.5	25	23	21					
50WQW15-40-5.5		42.5	41.7	40	38	36	34	32	30				
50WQW20-45-7.5		49.5	48.5	47	45	43	41	39	37				
50WQW20-55-11		58	57.4	56	55	53	52	50	47.5	45			
50WQW20-60-15		63	62.2	60.7	60	58.3	57	55	53.8	51.7	50	47.5	
65WQW15-7-0.75		9.7	9	7	5.3	3.7							
65WQW15-10-1.1		12.8	11.5	10	8	6.5							
65WQW25-10-1.5		15.5	14.4	13.4	11.7	10	8	5.9	3				
65WQW25-14-2.2		17.2	16.7	15.2	14.7	14	13	11.2	9.5	7.6	5.5		
65WQW25-18-3		23	22	20.9	19.6	18	16.5	14.3	12.5	10.2	7.4		
65WQW40-16-4	25.3	24	22.8	21.5	20.2	19	17.5	16.2	14.2	12.6	10.5		
65WQW30-25-5.5	31.5	30.5	29	28	26.5	25	23	21.7	19.9	18	16.2		
65WQW30-35-7.5	42	41	40	38.7	37.2	35	33	30.7	28	24.7	21		
65WQW40-45-11	53	52.5	51.3	50.6	49.5	48	47	45	43.8	42	40.2		
65WQW40-50-15	59	57.6	57	55	54.5	52.6	51	50	48	46	44.9		

Model	Q(m ³ /h)	10	20	30	40	50	60	70	80	90	100	110	
80WQW35-7-1.5	H (m)	10	8.9	7.6	6	4.4	2.5						
80WQW40-8-2.2		12	10.8	9.6	8	6.5	4.6						
80WQW35-13-3		17	15.5	14	12	9.7	6.7						
80WQW50-12-4		21	19.5	17.2	15	12	9	5.5					
80WQW40-22-5.5		30.8	28.2	25	22	17	12.1	7					
80WQW40-30-7.5		37	35	33	30	27.3	24.5	20.5	14				
80WQW60-35-11		42	41.2	40.2	39.7	37.3	35	33	30.6	27.6	23.8		
80WQW60-40-15		47	46.4	45	43.5	42	40	37.7	35	32	28.4		
100WQW50-10-3		15.5	14.2	13	10.8	10	7.5	5.8					
100WQW60-11-4		20.5	19	17.5	16	14	11	8	5				
100WQW65-15-5.5		21.8	21	20	19	18	16.5	14.5	12	8			
100WQW65-20-7.5		25.5	24.5	23.5	22.5	21.5	20.5	19.5	18.5	17	15	12.5	

Model	Q(m ³ /h)	20	40	60	80	100	120	140	160	180	200	220	
100WQW80-25-11	H (m)		35	30	25	19	12	3					
100WQW100-30-15			45	40	35	30	24	17					
150WQW100-10-5.5		16.5	15.5	13.7	12	10	8	5.8	3.5				
150WQW140-10-7.5		19	18.3	17	15.5	14	12	10	7.8	5.2			
150WQW140-15-11		27	25	23	21	19	17	15	13	11			
150WQW150-20-15		33	31	29	27.5	25.5	23	21	19	16	13		

Model	Q(m ³ /h)	30	60	90	120	150	180	210	240	270	300	330
200WQW180-10-11	H (m)	18.5	17	15.5	14	12.2	10	7	2			
200WQW180-15-15		23.5	22	20.5	19	17.2	15	13	10	4		

Note: WQWF stainless steel type no 40 discharge model

+- Performance curve

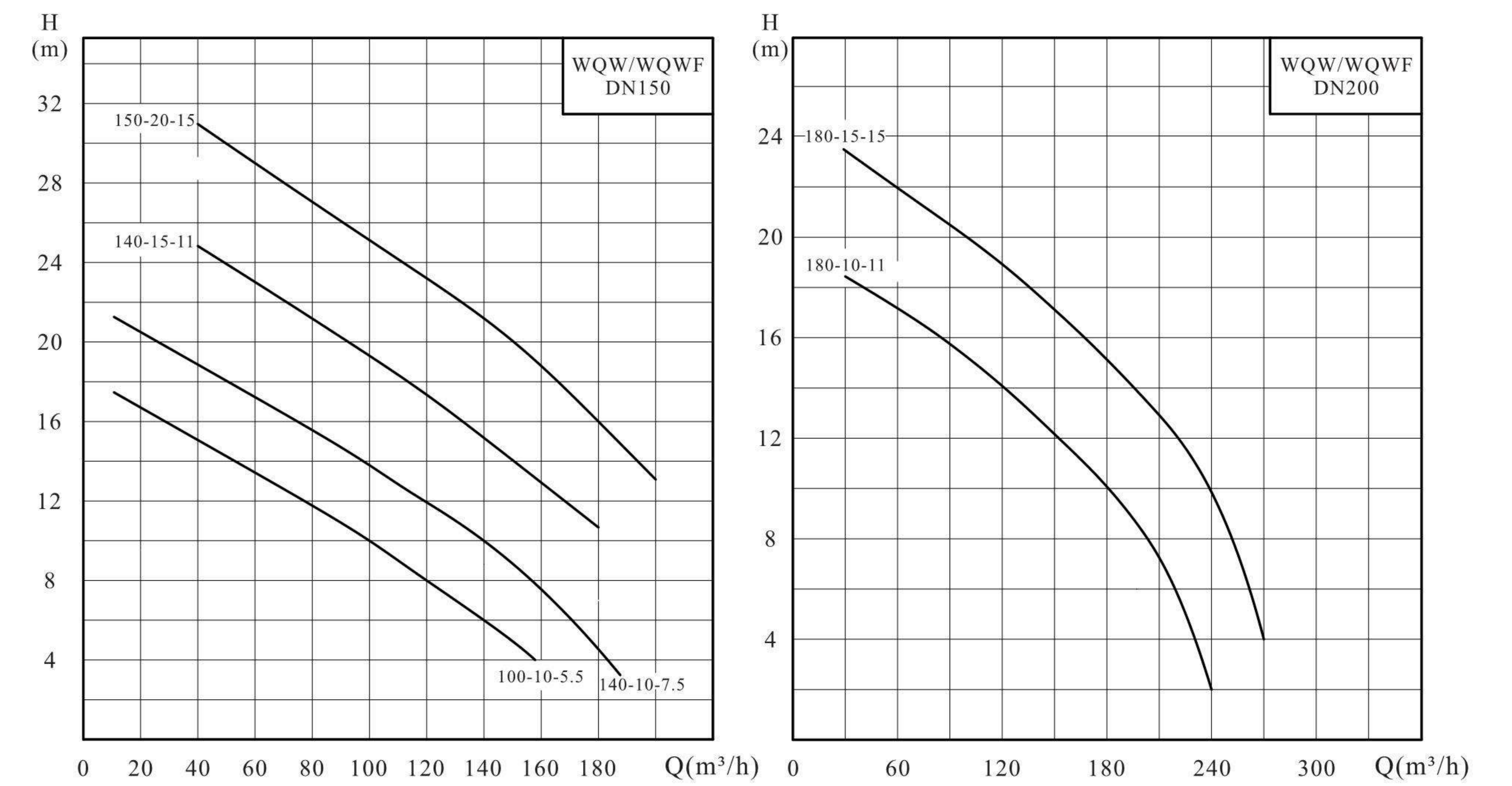
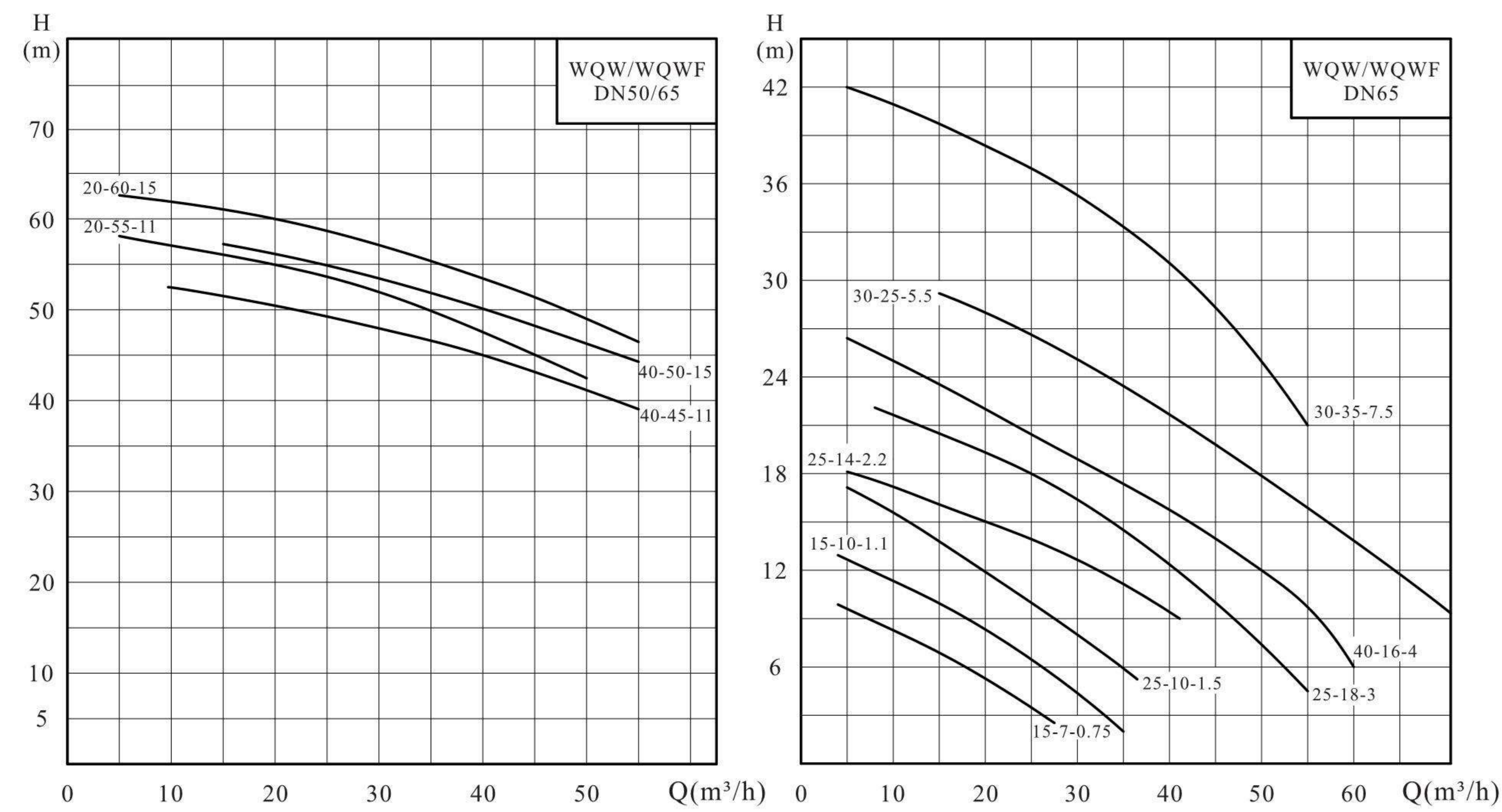
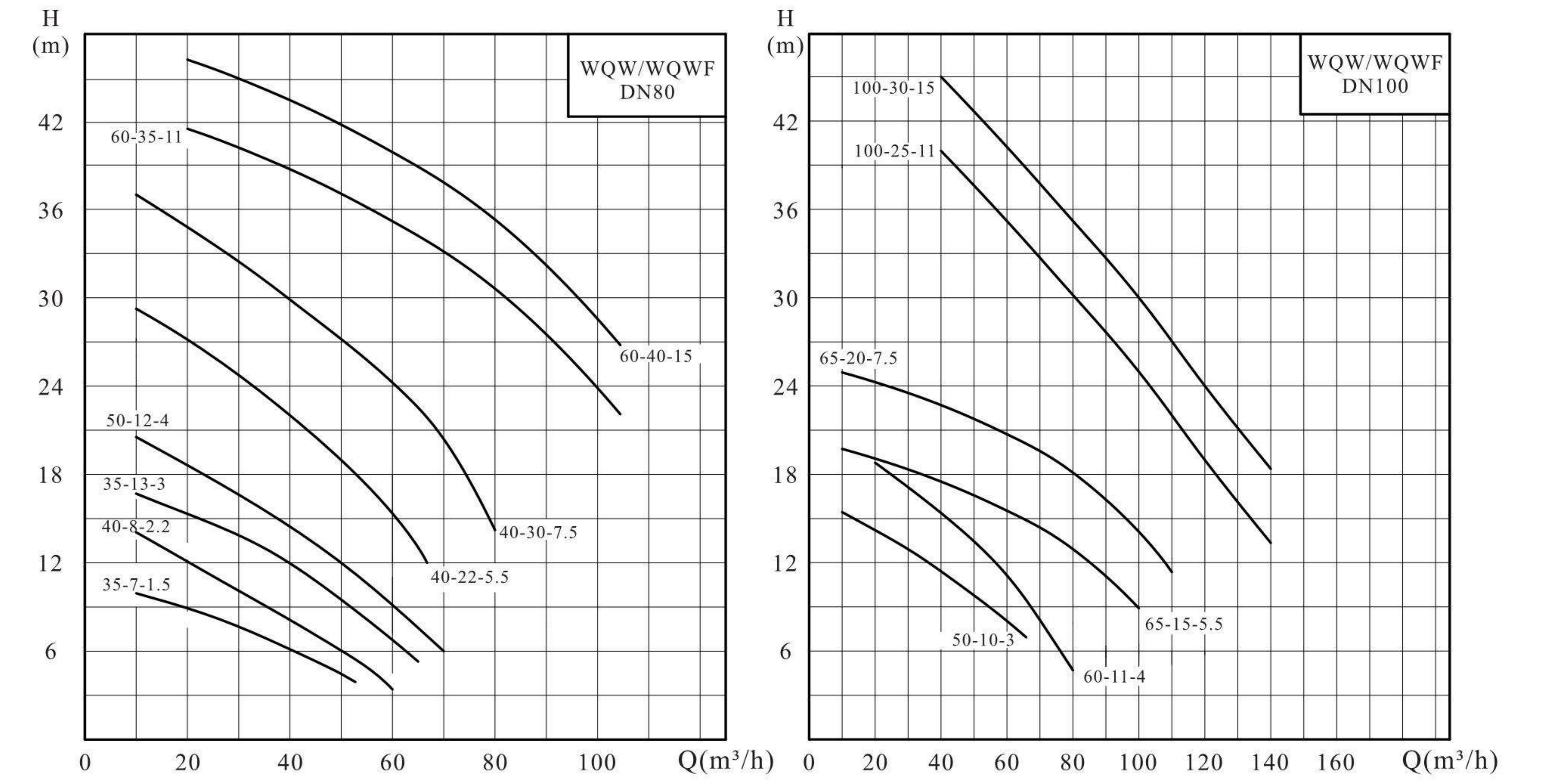
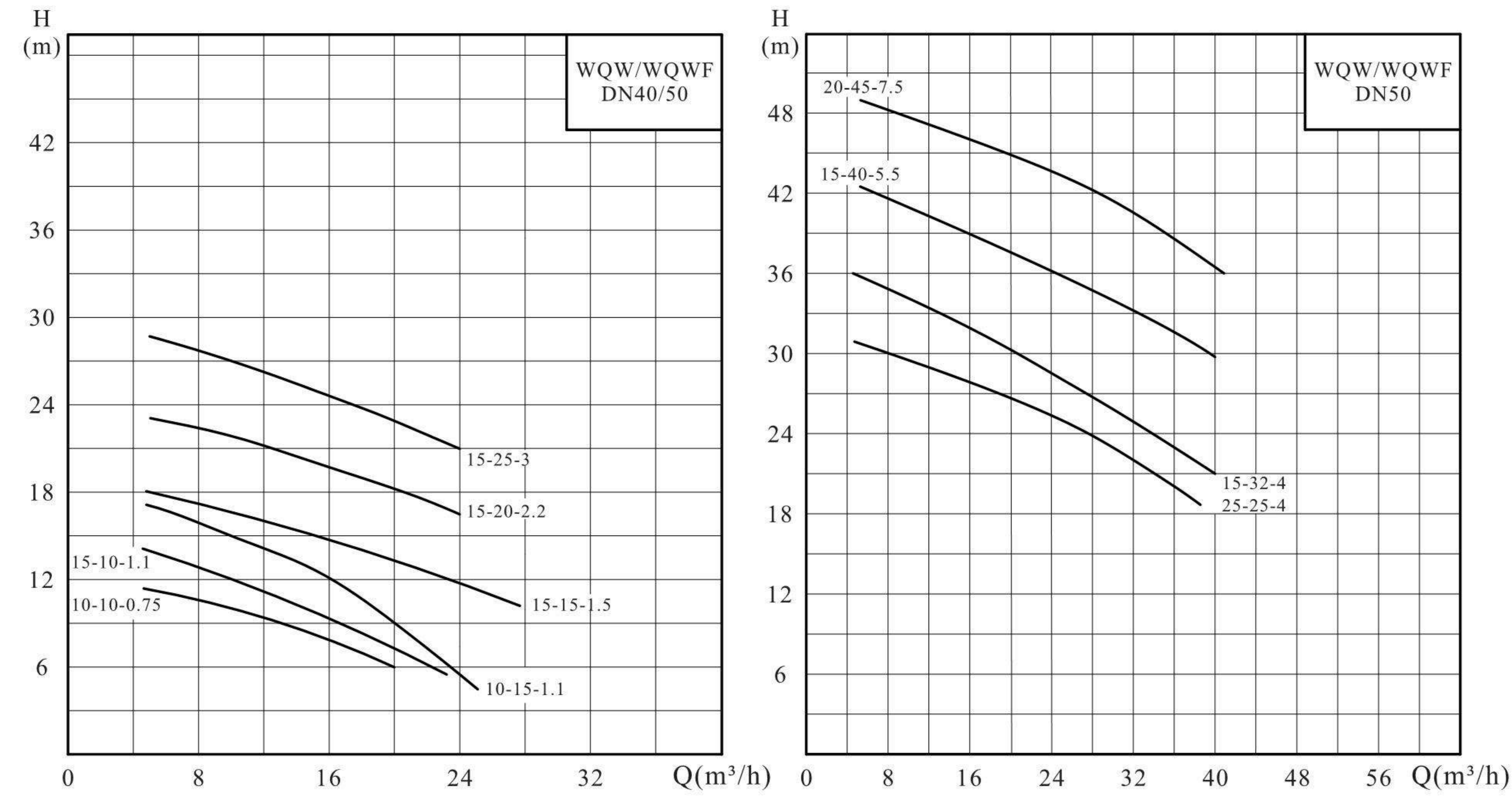

十二、WQW non-clogging cutting sewage pump

1、4 pole motor structure diagram (premium type)

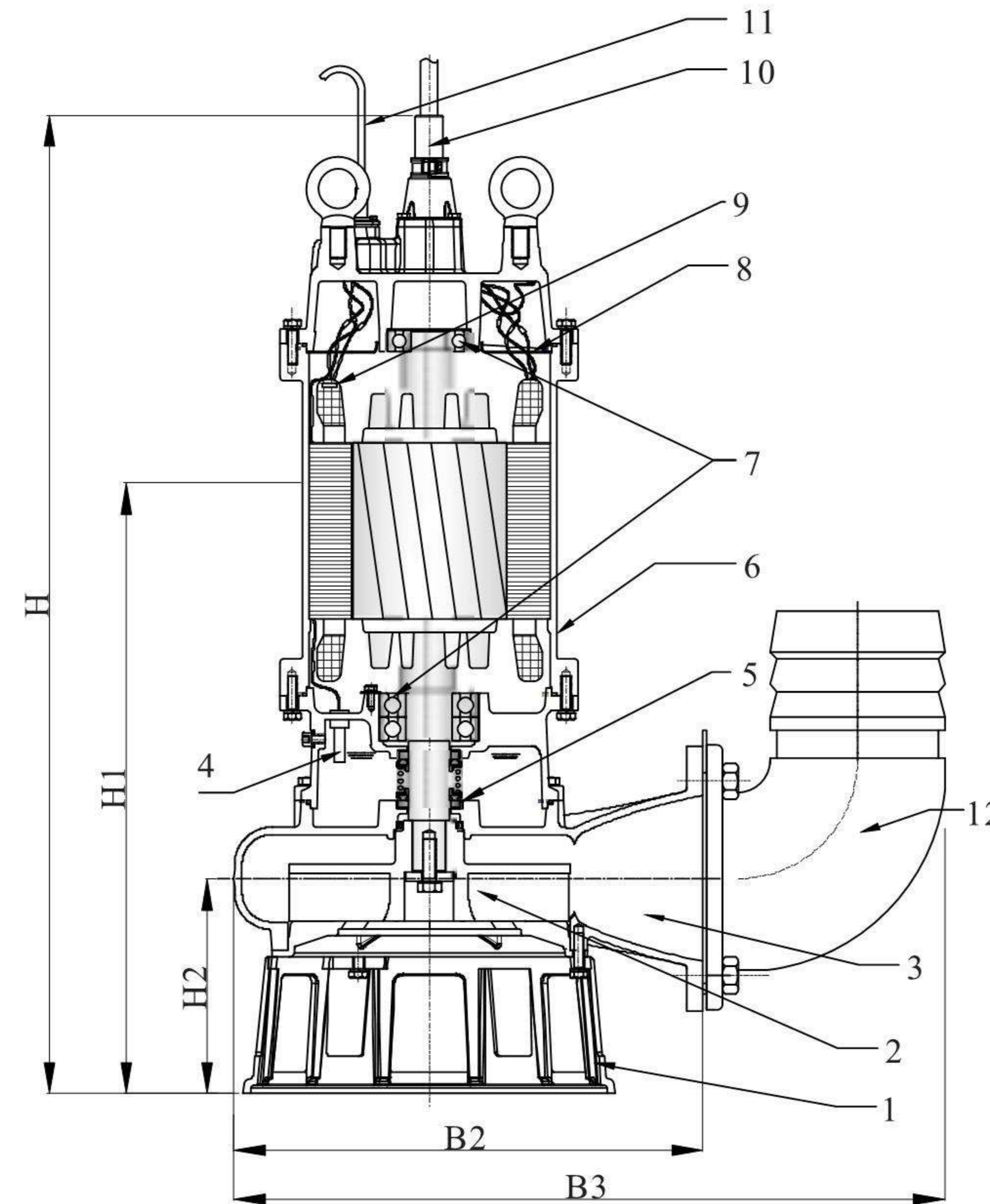

2、WQW 4 pole motor cast iron pump structure diagram table

S/N	Part name	Material	S/N	Part name	Material
1	Base	HT200	7	Bearing	Standard part
2	Impeller	QT600	8	Cable board	PA66
3	Pump body	HT200	9	Micro thermal protector	/
4	Water inlet sensor electrode	/	10	Power cable	YZW
5	Mechanical seal graphite	Silicon Carbide/ Tungsten Carbide	11	Induction cable line	YZW
6	Motor	/	12	Flange bend	HT200 (Optional)

十三、Technical parameters and dimensions (4-pole motor)

1. WQW cast iron non-clogging cutting sewage submersible pump

Model	Dia	Q	H	RPM	power	Current	Maximum diameter of particles passed	Weight	Overall dimension (mm)				
	mm	m ³ /h	m	rpm	kW	A			H	H1	H2	B2	B3
100WQW80-35-18.5	100	80	35	1450	18.5	35.6	30	290	1100	710	244	545	696
100WQW100-38-22	100	100	38	1450	22	43.2	30	300	1100	710	244	545	696
100WQW100-45-30	100	100	45	1450	30	57.5	30	320	1150	750	244	545	696
150WQW180-20-18.5	150	180	20	1450	18.5	35.6	50	295	1140	750	258	523	725
150WQW200-22-22	150	200	22	1450	22	43.2	50	305	1140	750	258	523	725
150WQW200-28-30	150	200	28	1450	30	57.5	55	325	1190	800	258	523	725
150WQW150-35-37	150	150	35	1450	37	72	55	590	1300	900	280	622	825
150WQW200-37-45	150	200	37	1450	45	87	55	630	1300	900	280	622	825
150WQW200-40-55	150	200	40	1450	55	106	55	790	1300	900	280	620	825
200WQW300-12-18.5	200	300	12	1450	18.5	35.6	60	300	1150	750	260	566	826
200WQW300-15-22	200	300	15	1450	22	43.2	60	310	1150	750	260	566	826
200WQW250-22-30	200	250	22	1450	30	57.5	45	330	1200	810	260	566	826
200WQW300-25-37	200	300	25	1450	37	72	45	610	1300	900	358	699	960
200WQW400-22-45	200	400	22	1450	45	87	60	650	1300	900	258	699	960
200WQW400-30-55	200	400	30	1450	55	106	60	810	1300	900	258	699	960
250WQW300-12-18.5	250	300	12	1450	18.5	35.6	60	320	1200	750	260	632	962
250WQW300-15-22	250	300	15	1450	22	43.2	60	330	1200	750	260	632	962
250WQW400-15-30	250	400	15	1450	30	57.5	60	342	1250	550	262	632	962
250WQW500-15-37	250	500	15	1450	37	72	60	630	1350	950	300	750	1080
250WQW600-15-45	250	600	15	1450	45	87	60	670	1350	950	300	750	1080
250WQW500-23-55	250	500	23	1450	55	106	60	810	1350	950	300	750	1080
300WQW400-9-18.5	300	400	9	1450	18.5	35.6	60	340	1200	750	270	687	1090
300WQW500-9-22	300	500	9	1450	22	43.2	60	350	1200	750	270	687	1090
300WQW500-11-30	300	500	11	1450	30	57.5	60	380	690	550	262	687	1090
300WQW600-12-37	300	600	12	1450	37	72	60	650	1370	970	292	720	1120
300WQW800-12-45	300	800	12	1450	45	87	60	690	1370	970	292	720	1120
300WQW600-20-55	300	600	20	1450	55	106	55	830	1370	970	292	720	1120

2、WQWF sewage pump automatic coupling installation dimension table

Item	Pump dia	50	65	80	100	150	200	250	300
Stainless steel guide rod dimensions Water pipe/seamless steel pipe		1"×(φ30×2)			1.5"×(φ45×2)				2"× (φ55×2.5)
Guide rod length MM		Pool depth - 80							
Specification and quantity of expansion bolts		M12×80×2			M14×100×2		M16×120×2		
Specification and quantity of anchor bolts		M16×250×4					M20×300×4		
Dimensions of the holes reserved for anchor bolts		80×80×300					100×100×350		
Inner diameter of the hose MM		50	65	80	100	150	200	250	300

WQW non-clogging cutting pump cast iron type 4-pole motor

Model	Q(m³/h)	20	40	60	80	100	120	140	160	180	200	220
100WQW80-35-18.5	H (m)	41	39	37	35	33	31	28	25			
100WQW100-38-22		46	44	42	40	38	35.8	33	30			
100WQW100-45-30		53	51	49	47	45	42.3	39.2	35.5	31		

Model	Q(m³/h)	50	100	150	200	250	300	350	400	450	500	550
150WQW180-20-18.5	H (m)	25	23	21	19	17	14.5	9				
150WQW200-22-22		29	27	25	22	20	17	13				
150WQW200-28-30		35.5	33.5	30.8	28	25	21.5	16				
150WQW150-35-37		39.8	37.6	35	31.8	28	23.3	18				
150WQW200-37-45		44	42	40	37	33	28	20				
150WQW200-40-55		55	50	45	40	35	30	25				
200WQW300-12-18.5		20.5	19.5	17.5	17	14.8	12	9	7	3		
200WQW300-15-22		21	20	19	18	17	15	12.4	10	3		

Model	Q(m³/h)	100	150	200	250	300	350	400	450	500	550	600
200WQW250-22-30	H (m)	29	26.5	24	22	20	17.5	13	8			
200WQW300-25-37		37	34	31	28	25	21	17	13			
200WQW400-25-45		40.5	38.5	36	33.5	31	28	25	21.5	17.8	14	10
200WQW400-30-55		48.8	46	43	39.5	36.3	33.2	30	25.8	22.5	18	12.5
250WQW300-12-18.5		20	18.5	17	14.5	12	9.5	7	4.5	2		
250WQW300-15-22		23	21.5	20	17.5	15	12.5	10	6	2		
250WQW400-15-30		25.5	24	22.5	20.7	19	17	15	12.5	10.5	8	

Model	Q(m³/h)	100	200	300	400	500	600	700	800	900	1000	1100
250WQW500-15-37	H (m)	20.8	19.5	18	16.7	15	11.5	6				
250WQW600-15-45		23	22	20.5	19	17	15	11	7			
250WQW500-23-55		29	28	27	25	23	21	19	17	11		
300WQW400-9-18.5		17	15	12.5	9	5.5	1.5					
300WQW500-9-22		20.5	18.5	16	13	9	4					
300WQW500-11-30		22.5	20.5	18	15	11	6	2				
300WQW600-12-37		26	23.5	21.2	17.8	15.6	12	8.9	4.5			
300WQW800-12-45			28	26	23.5	21	18.5	15.3	12	7.5	2.5	
300WQW600-20-55			30	27.5	25.5	23	20	17	13.7	8.5	3	

十四、Performance curve

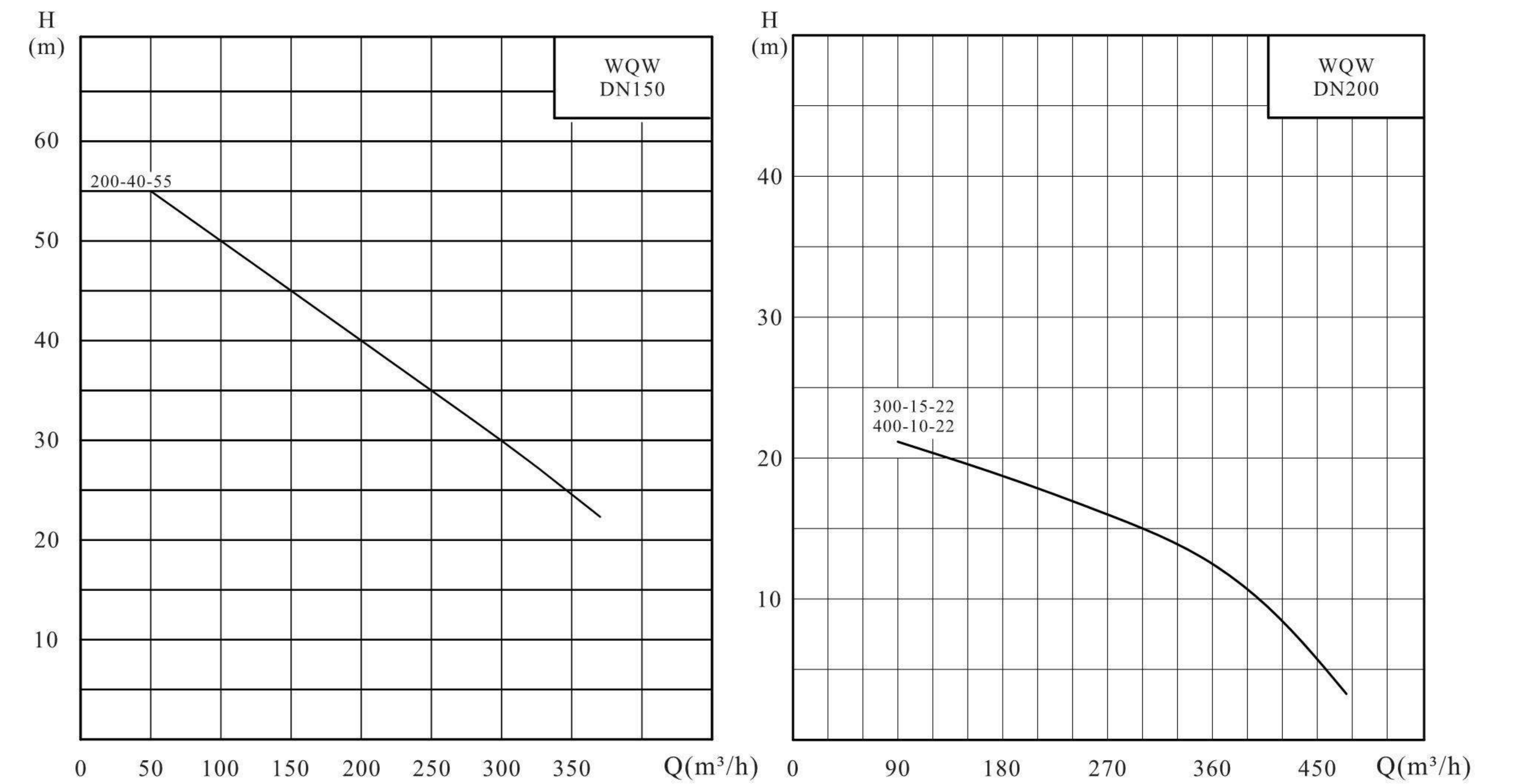
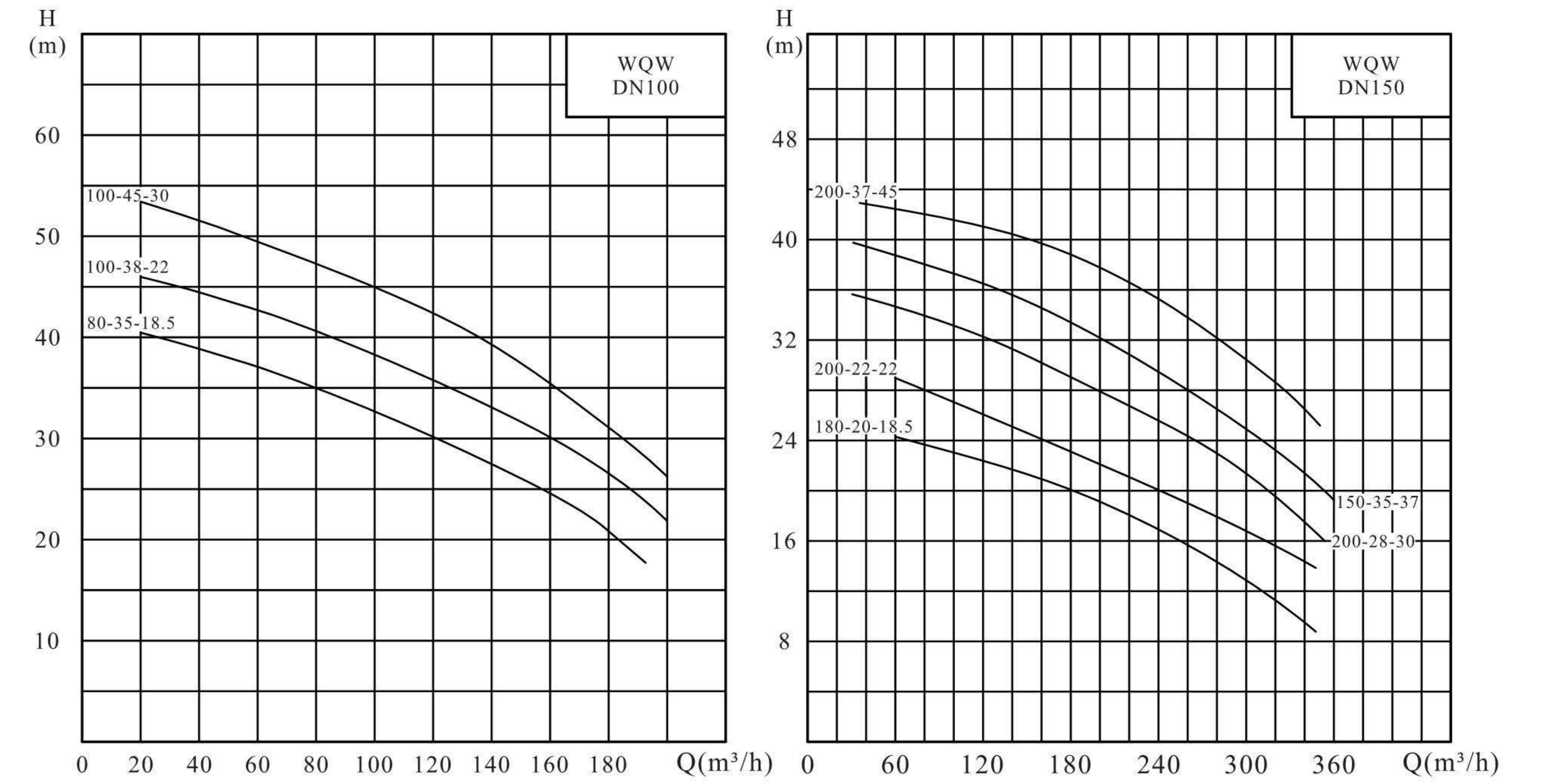

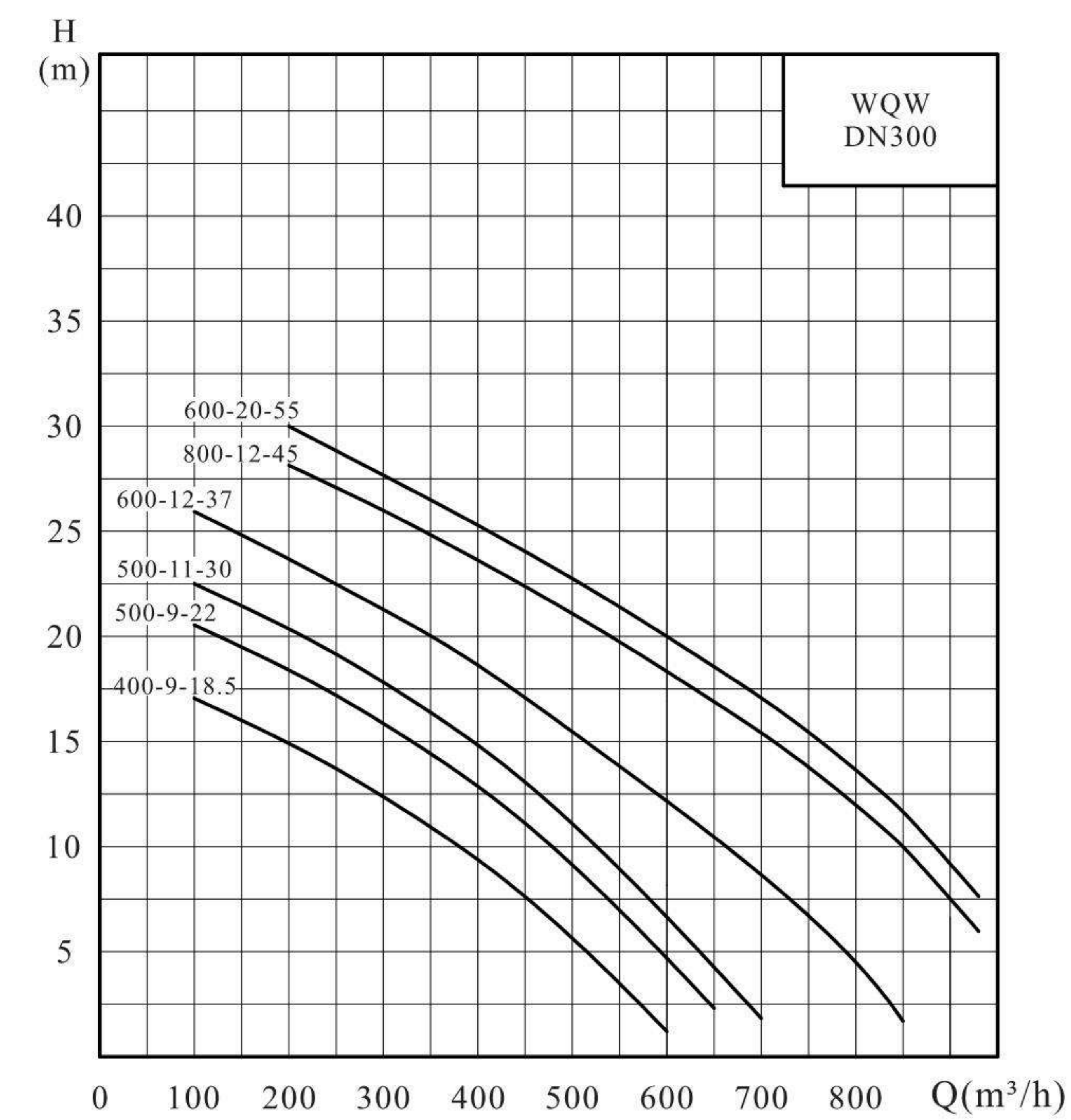
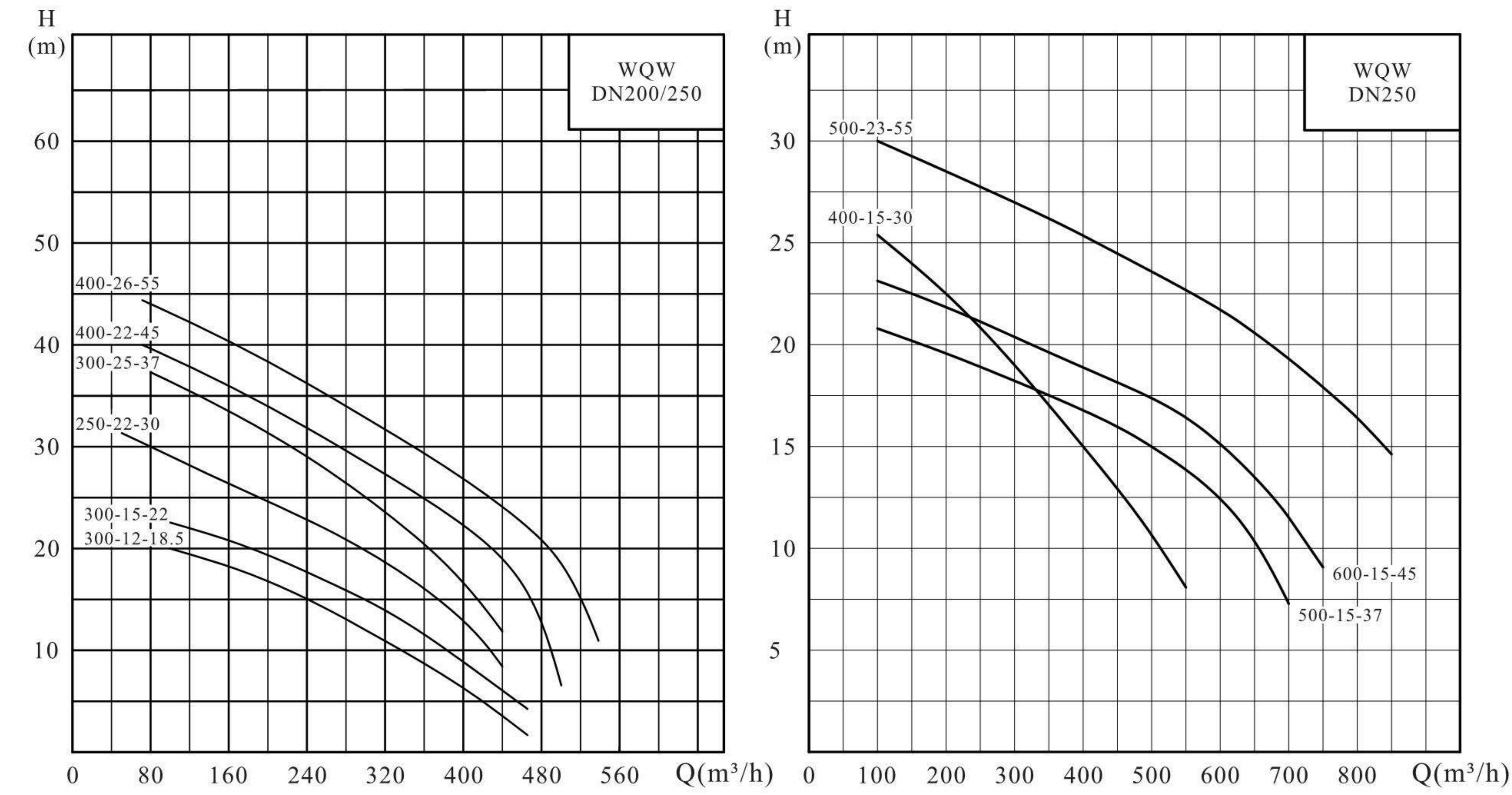

十五、WQ model of standard sewage pump

1、Structure chart

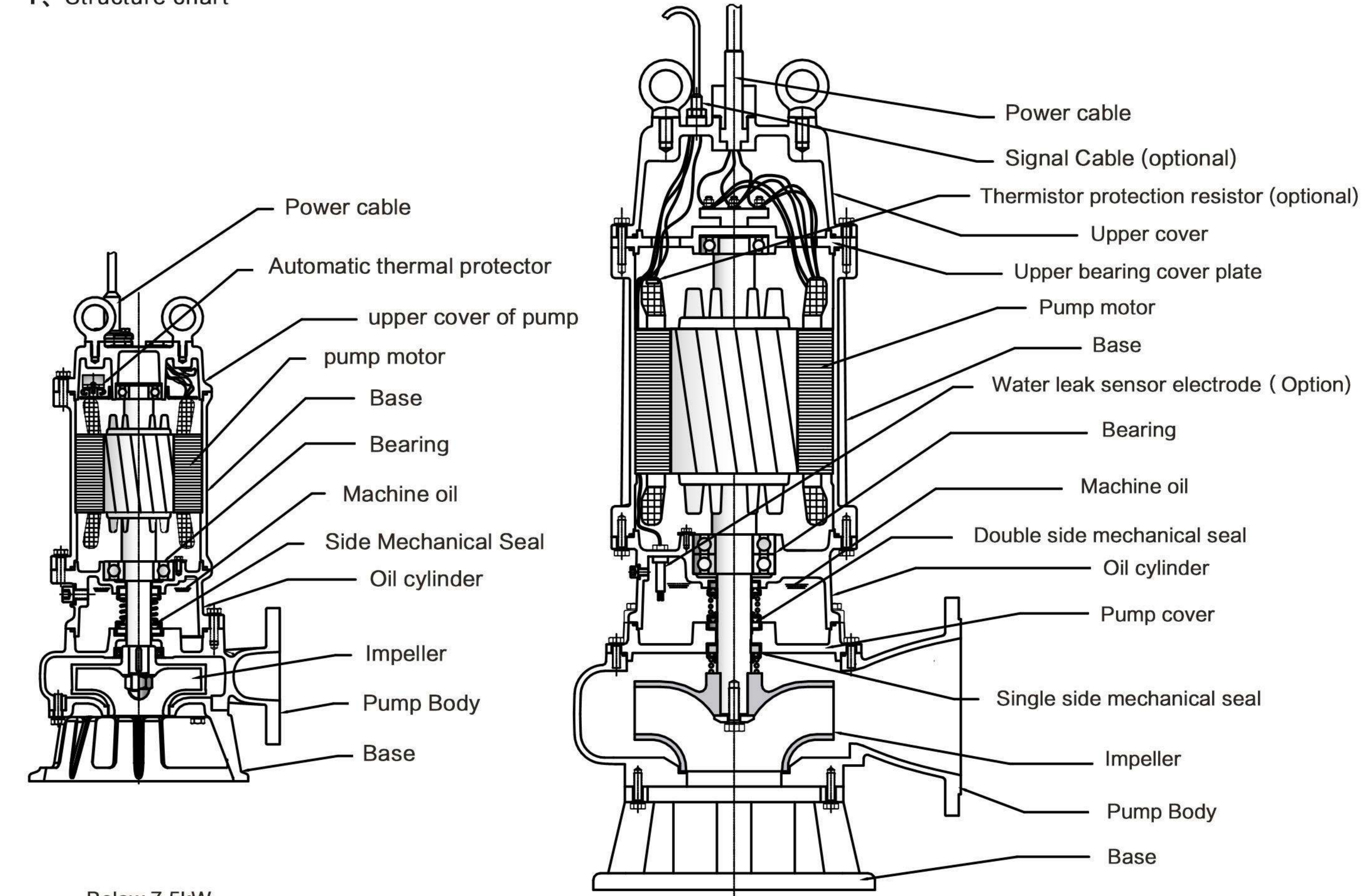

Below 7.5kW
(appearance same as WQW)

Above 11kW

2、model definition

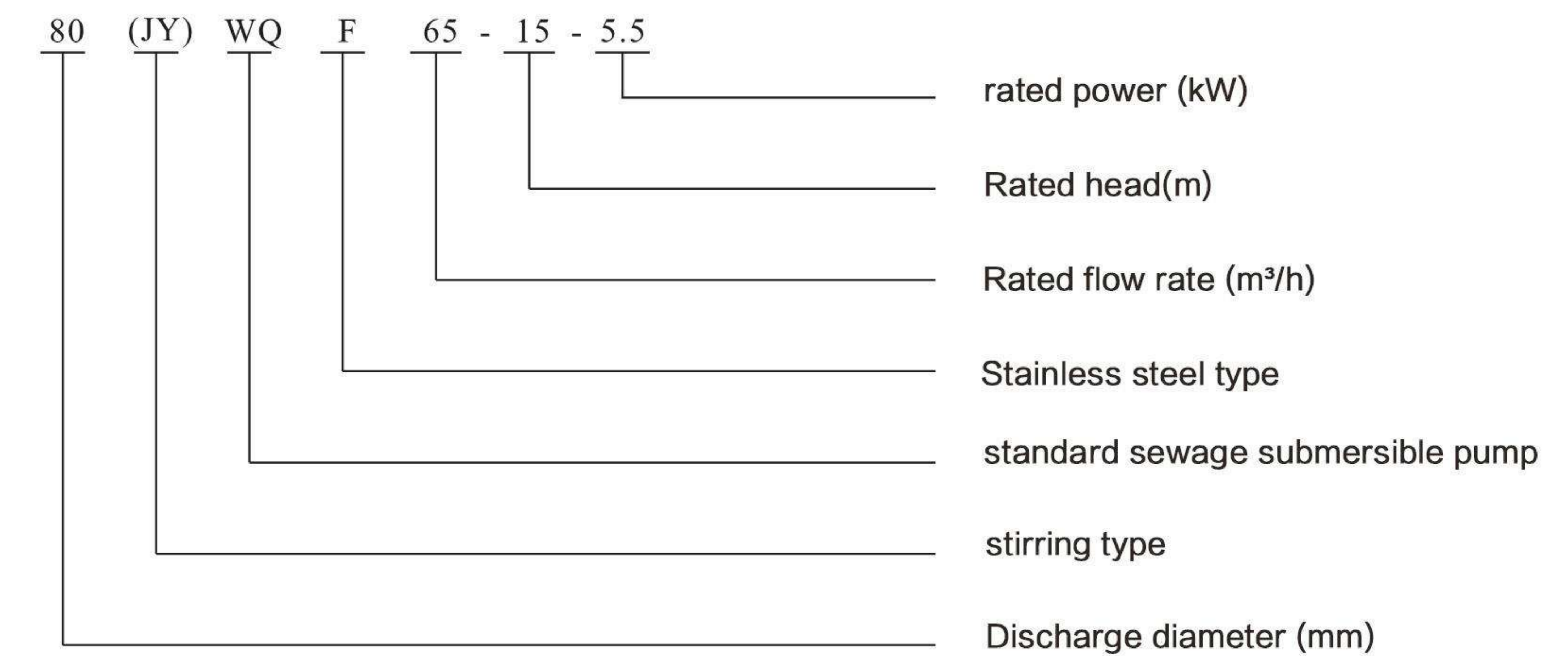

十六、Technical parameters and dimension

WQ standard sewage submersible pump data (WQF stainless steel type same parameters)

Dimensions are shown on page 3

diameter mm	Model	Flow m³/h	Head m	RPM rpm	Power kW	Overall dimension mm					
						H	H ₁	H ₂	B ₂	B ₃	
50	50WQ10-10-0.75	10	10	2900	0.75	400	300	93	217	312	
	50WQ15-10-1.1	15	10	2900	1.1	415	315	93	217	312	
	50WQ10-15-1.1	10	15	2900	1.1	415	315	93	217	312	
	50WQ15-15-1.5	15	15	2900	1.5	493	370	103	250	345	
	50WQ15-20-2.2	15	20	2900	2.2	518	390	103	250	345	
	50WQ15-25-3	15	25	2900	3	535	405	120	291	386	
	50WQ15-32-4	15	32	2900	4	565	435	120	291	386	
	50WQ15-40-5.5	15	40	2900	5.5	650	510	123	313	408	
	50WQ20-42-7.5	20	42	2900	7.5	690	550	123	313	408	
	50WQ20-50-11	20	50	2900	11	765	480	131	372	467	
	50WQ20-60-15	20	60	2900	15	805	520	131	372	467	
	50WQ20-70-18.5	20	70	2900	18.5	900	680	150	407	502	
	50WQ20-80-22	20	80	2900	22	950	700	150	407	502	
	65	65WQ15-7-0.75	15	7	2900	0.75	400	300	93	217	312
		65WQ15-10-1.1	15	10	2900	1.1	415	315	93	217	312
		65WQ25-10-1.5	25	10	2900	1.5	493	370	103	250	345
65WQ25-14-2.2		25	14	2900	2.2	518	390	103	250	345	
65WQ25-18-3		25	18	2900	3	535	405	120	291	386	
65WQ40-16-4		40	16	2900	4	565	435	120	291	396	
65WQ30-25-5.5		30	25	2900	5.5	650	510	123	313	408	
65WQ30-30-7.5		30	30	2900	7.5	690	550	123	313	418	
65WQ30-40-11		30	40	2900	11	765	480	131	372	467	
65WQ30-60-15		30	60	2900	15	805	520	131	372	467	
80	80WQ35-7-1.5	35	7	2900	1.5	505	390	107	276	401	
	80WQ40-10-2.2	40	10	2900	2.2	530	415	107	276	401	
	80WQ40-12-3	40	12	2900	3	560	430	130	295	420	
	80WQ50-12-4	50	12	2900	4	590	460	130	295	420	
	80WQ40-22-5.5	40	22	2900	5.5	660	520	125	325	450	
	80WQ40-30-7.5	40	30	2900	7.5	700	560	125	325	450	
	80WQ60-30-11	60	30	2900	11	810	550	160	400	525	
	80WQ60-36-15	60	36	2900	15	860	600	160	400	525	
	80WQ60-45-18.5	60	45	2900	18.5	960	700	165	407	532	
	80WQ60-50-22	60	50	2900	22	1010	780	165	407	532	

diameter mm	Model	Flow m³/h	Head m	RPM rpm	Power kW	Overall dimension mm				
						H	H ₁	H ₂	B ₂	B ₃
100	100WQ50-10-3	50	10	2900	3	580	450	136	306	456
	100WQ60-11-4	60	11	2900	4	608	488	136	306	456
	100WQ65-15-5.5	65	15	2900	5.5	690	550	143	320	470
	100WQ65-20-7.5	65	20	2900	7.5	730	590	143	320	470
	100WQ110-10-5.5	110	10	1450	5.5	810	550	180	400	550
	100WQ100-15-7.5	100	15	1450	7.5	860	600	180	400	550
	100WQ80-25-11	80	25	2900	11	810	550	180	400	550
	100WQ80-35-15	80	35	2900	15	860	600	180	400	550
	100WQ100-25-11	100	25	1450	11	910	630	185	480	630
	100WQ100-30-15	100	30	1450	15	950	650	185	480	630
	100WQ80-37-18.5	80	37	2900	18.5	960	650	173	407	557
	100WQ80-44-22	80	44	2900	22	1001	680	173	407	557
	100WQ100-35-18.5	100	35	1450	18.5	1263	950	250	550	700
	100WQ100-40-22	100	40	1450	22	1290	980	250	550	700
	100WQ100-45-30	100	45	1450	30	1340	1000	272	602	752
	100WQ100-48-37	100	48	1450	37	1408	1050	272	602	752
	100WQ100-50-45	100	50	1450	45	1490	1100	270	675	825
	100WQ100-60-55	100	60	1450	55	1622	1200	270	675	825
	100WQ100-75-75	100	75	1450	75	1520	1150	150	750	900
	150	100WQ140-80-90	140	80	1450	90	1630	1200	150	750
100WQ140-88-110		140	88	1450	110	1760	1300	150	750	900
150WQ100-11-5.5		100	11	2900	5.5	707	550	150	356	556
150WQ140-10-7.5		140	10	2900	7.5	747	600	150	356	556
150WQ140-15-11		140	15	2900	11	860	630	171	380	580
150WQ150-20-15		150	20	2900	15	910	650	171	380	580
150WQ180-11-11		180	11	1450	11	939	670	206	525	725
150WQ180-15-15		180	15	1450	15	979	700	206	525	725
150WQ200-18-18.5		200	18	2900	18.5	981	700	185	366	566
150WQ200-22-22		200	22	2900	22	1011	730	185	366	566
150WQ250-15-18.5		250	15	1450	18.5	1238	900	223	567	767
150WQ200-20-22		200	20	1450	22	1264	930	223	567	767
150WQ200-25-30		200	25	1450	30	1300	1000	235	647	847
150WQ200-30-37		200	30	1450	37	1368	1050	235	647	847
150WQ200-35-45		200	35	1450	45	1453	1200	236	647	875
150WQ200-40-55		200	40	1450	55	1622	1300	355	675	875
150WQ200-58-75		200	58	1450	75	1609	1300	258	764	964
150WQ200-60-90		200	60	1450	90	1684	1350	258	764	964
150WQ200-74-110	200	74	1450	110	1796	1400	245	732	932	
150WQ200-80-132	200	80	1450	132	1795	1400	203	884	1084	
150WQ300-90-160	300	90	1450	160	1795	1400	203	884	1084	
150WQ400-88-185	400	88	1450	185	1795	1400	203	884	1084	

diameter mm	Model	Flow m³/h	Head m	RPM rpm	Power kW	Overall dimension mm				
						H	H ₁	H ₂	B ₂	B ₃
200	200WQ220-6-7.5	220	6	1450	7.5	910	600	205	450	700
	200WQ180-11-11	180	11	2900	11	890	600	185	430	680
	200WQ180-15-15	180	15	2900	15	922	600	185	430	680
	200WQ300-7-11	300	7	1450	11	979	650	206	525	775
	200WQ250-11-15	250	11	1450	15	979	650	206	525	775
	200WQ180-18-18.5	180	18	2900	18.5	974	600	185	424	674
	200WQ200-20-22	200	20	2900	22	1004	650	185	424	674
	200WQ300-12-18.5	300	12	1450	18.5	1238	900	223	567	817
	200WQ300-15-22	300	15	1450	22	1264	930	223	567	817
	200WQ250-22-30	250	22	1450	30	1321	1000	253	648	898
	200WQ250-27-37	250	27	1450	37	1390	1050	253	648	898
	200WQ350-23-37	350	23	1450	37	1390	1050	253	648	898
	200WQ250-30-45	250	30	1450	45	1578	1250	353	650	900
	200WQ360-26-45	360	26	1450	45	1578	1250	353	650	900
	200WQ400-30-55	400	30	1450	55	1647	1300	353	650	900
	200WQ350-45-75	350	45	1450	75	1609	1300	258	764	1014
	200WQ300-53-90	300	53	1450	90	1684	1350	258	764	1014
	200WQ380-50-90	380	50	1450	90	1684	1350	258	764	1014
	200WQ320-65-110	320	65	1450	110	1814	1450	258	764	1014
	200WQ400-75-132	400	75	1450	132	1795	1400	203	884	1134
200WQ360-90-160	360	90	1450	160	1795	1400	203	884	1134	
200WQ450-85-185	450	85	1450	185	1926	1520	203	884	1134	
250	250WQ400-5-11	400	5	1450	11	987	650	239	592	892
	250WQ400-6-15	400	6	1450	15	1028	700	239	592	892
	250WQ400-10-18.5	400	10	1450	18.5	1265	930	230	636	936
	250WQ500-9-22	500	9	1450	22	1291	1000	230	636	936
	250WQ500-12-30	500	12	1450	30	1349	1050	276	740	1040
	250WQ500-17-37	500	17	1450	37	1420	1100	276	740	1040
	250WQ600-15-45	600	15	1450	45	1504	1150	276	740	1040
	250WQ600-20-55	600	20	1450	55	1571	1200	243	710	1010
	250WQ600-26-75	600	26	1450	75	1647	1250	294	807	1107
	250WQ600-32-90	600	32	1450	90	1720	1350	294	807	1107
	250WQ600-38-110	600	38	1450	110	1852	1450	294	807	1107
	250WQ600-46-132	600	46	1450	132	1928	1520	309	890	1190
	250WQ600-60-160	600	60	1450	160	1928	1520	309	890	1190
	250WQ600-65-185	600	65	1450	185	2137	1730	387	970	1270
	300	300WQ650-5-18.5	650	5	1450	18.5	1294	1000	244	712
300WQ650-7-22		650	7	1450	22	1320	1000	244	712	1062
300WQ800-7-30		800	7	1450	30	1347	1050	243	712	1062
300WQ800-9-37		800	9	1450	37	1417	1120	243	712	1062
300WQ800-12-45		800	12	1450	45	1500	1200	243	712	1062
300WQ600-20-55		600	20	1450	55	1571	1250	243	712	1062
300WQ800-20-75		800	20	1450	75	1620	1300	243	760	1110
300WQ800-26-90		800	26	1450	90	1694	1350	243	760	1110
300WQ800-32-110		800	32	1450	110	1824	1450	243	760	1110
300WQ800-37-132		800	37	1450	132	1896	1500	243	865	1215
300WQ800-40-160		800	40	1450	160	1896	1500	243	865	1215
300WQ900-40-185		900	40	1450	185	2027	1600	243	865	1215
300WQ900-45-200		900	45	1450	200	2027	1600	243	865	1215
300WQ1000-45-250		1000	45	1450	250	2386	1950	376	1100	1450
300WQ1000-63-315		1000	63	1450	315	2415	2000	376	1100	1450



diameter mm	Model	Flow m³/h	Head m	RPM rpm	Power kW	Overall dimension mm					
						H	H ₁	H ₂	B ₂	B ₃	
350	350WQ1000-6-30	1000	6	980	30	1500	1200	268	907	1307	
	350WQ1200-6-37	1200	6	980	37	1500	1200	268	907	1307	
	350WQ1200-8-45	1200	8	980	45	1584	1300	268	907	1307	
	350WQ1100-7-45	1100	7	1450	45	1554	1250	273	870	1270	
	350WQ1100-10-55	1100	10	1450	55	1623	1300	273	870	1270	
	350WQ1200-13-75	1200	13	1450	75	1685	1350	273	870	1270	
	350WQ1200-14-75	1200	14	980	75	1794	1450	273	1000	1400	
	350WQ1200-17-90	1200	17	980	90	1924	1550	273	1000	1400	
	350WQ1000-20-90	1000	20	1450	90	1752	1400	273	870	1270	
	350WQ1000-23-110	1000	23	1450	110	1932	1550	303	920	1320	
	350WQ1500-16-110	1500	16	980	110	1924	1550	273	1000	1400	
	350WQ1500-18-132	1500	18	980	132	2218	1800	411	1230	1630	
	350WQ1100-30-132	1100	30	1450	132	1924	1550	273	1000	1400	
	350WQ1500-26-160	1500	26	1450	160	1924	1550	273	1000	1400	
	350WQ1200-30-185	1200	30	1450	185	2055	1650	273	1000	1400	
	350WQ2000-20-200	2000	20	980	200	2258	1850	303	1190	1590	
	350WQ1500-35-250	1500	35	1450	250	2277	1850	273	1000	1400	
	350WQ1500-45-315	1500	45	1450	315	2378	1950	273	1170	1570	
	400	400WQ1000-8-37	1000	8	980	37	1529	1200	298	950	1400
		400WQ1200-8-45	1200	8	980	45	1614	1300	298	950	1400
400WQ1300-8-55		1300	8	1450	55	1714	1350	303	920	1370	
400WQ1200-10-55		1200	10	980	55	1683	1350	298	1000	1450	
400WQ1500-10-75		1500	10	980	75	1824	1450	303	1025	1475	
400WQ1500-16-90		1500	16	980	90	1954	1550	303	1025	1475	
400WQ1600-15-110		1600	15	980	110	1954	1550	303	1025	1475	
400WQ2000-13-132		2000	13	980	132	2135	1800	303	1216	1666	
400WQ2000-18-160		2000	18	980	160	2135	1800	303	1216	1666	
400WQ1500-22-160		1500	22	1450	160	1954	1550	303	1025	1475	
400WQ1600-25-185		1600	25	1450	185	2085	1650	303	1025	1475	
400WQ2000-20-185		2000	20	980	185	2143	1800	302	1206	1656	
400WQ2000-22-200		2000	22	980	200	2258	1850	303	1191	1641	
400WQ2000-28-250		2000	28	980	250	2496	2100	322	1300	1750	
400WQ1500-35-250		1500	35	1450	250	2311	1900	303	1025	1475	
400WQ2000-36-315	2000	36	1450	315	2311	1900	303	1025	1475		
500	500WQ2200-5-55	2200	5	980	55	1796	1450	355	1190	1740	
	500WQ2000-8-75	2000	8	980	75	1871	1500	355	1190	1740	
	500WQ1800-12-90	1800	12	980	90	2001	1600	355	1190	1740	
	500WQ2500-10-110	2500	10	740	110	2166	1800	355	1375	1925	
	500WQ2500-12-132	2500	12	740	132	2544	2100	355	1425	1975	
	500WQ2500-13-160	2500	13	980	160	2187	1800	335	1246	1796	
	500WQ2500-18-185	2500	18	740	185	2604	2200	355	1425	1975	
	500WQ2500-15-185	2500	15	980	185	2336	1900	355	1375	1925	
	500WQ2500-18-200	2500	18	980	200	2336	1900	355	1375	1925	
	500WQ3000-18-250	3000	18	980	250	2544	2100	355	1425	1975	
600	600WQ3100-7.5-132	3100	7.5	740	132	2251	1850	410	1590	2240	
	600WQ3300-10-160	3300	10	740	160	2544	2100	355	1425	2075	
	600WQ2500-14-185	2500	14	980	185	2518	2100	410	1276	1926	
	600WQ2500-16-200	2500	16	980	200	2518	2100	410	1276	1926	
	600WQ3200-13-200	3200	13	980	200	2518	2100	410	1276	1926	
	600WQ4000-18-250	4000	18	980	250	2544	2100	355	1425	2075	
	600WQ4500-20-315	4500	20	980	315	2421	2000	410	1590	2240	

WQF SS model,max dia is 300mm,max power 132kW



WQ standard sewage submersible pump data (WQF stainless steel type same parameters)

Model	Q(m³/h)	5	10	15	20	25	30	35	40	45	50	55	
50WQ10-10-0.75	H (m)	11.5	10	8.5	7								
50WQ10-13-1.1		15	13	11.5	10	8							
50WQ15-10-1.1		14	12	10	7.5	5							
50WQ15-15-1.5		18	16.5	15	13.3	11.5	9						
50WQ15-18-2.2		21.5	20	18	17	16	14.5	12.5					
50WQ15-25-3		27	26	25	23.5	22	20	18					
50WQ15-32-4		36	34	32	30	28	26.5	23.6	21				
50WQ15-40-5.5		42.5	41.7	40	38	36	34	32	30				
50WQ20-42-7.5		46	44.5	43.5	42	40	38	36	34				
50WQ20-50-11		54	53	51.5	50	48.5	47	45.5	44	42.5	41	38	
50WQ20-60-15		63	62.2	60.7	60	59	57.5	56	55	53	51	49	
65WQ15-7-0.75		9.7	9	7	5.3	3.7							
65WQ15-10-1.1		13	11.5	10	8	6							
65WQ25-10-1.5		14.5	13	12	11	10	8						
65WQ25-14-2.2		18	17	16	15	14	12	10					
65WQ25-18-3		23	22	20.9	19.6	18	17	16	14.5				
65WQ40-16-4		27	25.5	24	22.5	21	19.5	18	16	14.7	12.6	10.5	
65WQ30-25-5.5		31	30	29	28	26.5	25	23	21.5	19.5	16		
65WQ30-30-7.5		35	34	33	32	31	30	29	27.5	26	25	23	
65WQ40-45-11		53	52	51	50	48.5	47.5	46	45	43	41	38	
65WQ40-50-15	58	57	56	55	53.5	52.5	51	50	48	46	44		

Model	Q(m³/h)	10	20	30	40	50	60	70	80	90	100	110	120
80WQ35-7-1.5	H (m)	10	8.9	7.6	6	4.4							
80WQ40-10-2.2		14	13	11.5	10	8	6						
80WQ40-12-3		17	15	13.5	12	11	9.5						
80WQ50-15-4		20	18.5	17.2	16	15	13	11					
80WQ40-20-5.5		25	23.5	22	20	18	16	12					
80WQ40-30-7.5		36	34	32	30	27	23	17					
80WQ60-30-11		43	40	37	35	33	30	27	23				
80WQ60-36-15		42	41	40	39	38	36	34.5	33	31.5	30	27	
100WQ50-10-3		14	13	12	11	10	9	8	7	6			
100WQ60-11-4		16	15	14	13	12	11	10	9	8	7		
100WQ65-15-5.5		20.5	19.5	18.5	17.5	16.5	15.5	14.5	13.5	12.5	11	10	9
100WQ100-15-7.5		23	22	21	20	19	18	17.5	17	16	15	14	13
100WQ100-25-11		36	35	34	32.5	31	30	28.5	27	26	25	21	17
100WQ100-30-15		42	41	40	39	37.5	36	35	34	32	30	27	23
100WQ80-37-18.5		44	43	42	41	40	39	38	37	36	35	33	20
100WQ80-44-22		51	50.5	49.5	49	48	47	46	44	42	40	39	21

Model	Q(m³/h)	40	60	80	100	120	140	160	180	200	220	240	260
150WQ100-11-5.5	H (m)	14	12	12	11	10	8.5	7	6	4	2		
150WQ140-10-7.5		16	15	14	13	11.5	10	8.5	7	5.5	4		
150WQ180-11-11		18	17.5	17	16.5	15.5	14.5	13	11	10.2	8.5	6.5	4.5
150WQ180-15-15		23.5	22.5	21.5	20.5	19.5	18.2	17	15	14	13	11	9
150WQ200-18-18.5		27.5	26.5	25.5	24.5	23.5	22.5	21.5	20	18	16	14	11
150WQ200-22-22		32.5	31.5	30.5	29.5	28.3	27	25.5	24	22	20	17.5	15

Model	Q(m³/h)	80	100	120	140	160	180	200	220	240	260	280
150WQ200-25-30	H (m)	31	30	29	28	27	26	25	23	21.5	20	
150WQ200-30-37			35	34	33	32	31	30	29	27.5	26.5	24
150WQ200-35-45		42	41	39	38	37	36	35	34	32.5	31.5	30
150WQ200-40-55		46	45	44	43	42	41	40	38.5	36	34	31
150WQ200-58-75		64	63	62	61	60	59	58	57	56	55	54
150WQ300-55-90		61	60	59	58	57	56	55	54	53	52	51
150WQ200-74-110		82	80.5	79	77.5	76	75	74	72	70	68	66
150WQ200-80-132		86	85	84	83	82	81	80	79	78	77	76
200WQ220-6-7.5		12	11.5	11	10.5	10	8.5	7.5	6	4.5	3	2

Model	Q(m³/h)	150	200	250	300	350	400	450	500	550	600	650
200WQ300-7-11	H (m)	15	13	10	7	3						
200WQ250-11-15		16	14	11	7	2						
200WQ300-12-18.5		18	16	14	12	8	5					
200WQ300-15-22		23	20	18	15	12	10	3				
200WQ250-22-30		25.5	24	22	20	18	15	11				
200WQ300-20-30		25.5	24	22	20	18	15	11	4			
200WQ300-25-37			28.5	27	25	23	20.5	17.5	8			
200WQ300-28-45		33	31.5	30	28	26	24	20	7.5			
200WQ300-37-55		42	41	39	37	34.5	32	20				
200WQ350-40-75		49	47	45	43	40	35	25				
200WQ300-53-90		58	56.5	55	53	51	48	20				
200WQ300-65-110		72	70	67.5	65	62.5	58.5	31				
200WQ400-75-132		87	84.5	82	79.5	77.5	75	70	64			
200WQ300-95-160		100	99	97	95	92	85.5					
200WQ450-85-185		100	98	96	94	91	88	85	80	75	69	
250WQ400-6-15		12	11	10	9	7.5	6	4.8	3.5	1.5		
250WQ400-10-18.5		15.5	14.5	13.5	12.5	11.2	10	8	6	2.5		
250WQ500-9-22		18.5	17.5	16.5	15.5	14	12.5	11	9	8	6	4

Model	Q(m³/h)	200	300	400	500	600	700	800	900	1000	1100	1200
250WQ600-9-30	H (m)	17.5	16.5	14.5	12.5	9	5.5					
250WQ600-12-37		20	19	17	15	12	5.8					
250WQ600-15-45		24	22.5	21	19.5	15	10.8					
250WQ600-20-55		27	26	24.8	23	20	14	3				
250WQ600-26-75		34	32	30	28.5	26	24	17				
250WQ500-34-90		39	37.5	36	34	32	18	2				
250WQ600-38-110		45	43	41	39.5	38	35	33	29	24		
250WQ600-46-132		54	52	50	48	46	41	26				
250WQ600-60-160		70	67.5	65	62.5	60	56					
250WQ600-65-185		72.5	72	70	68	65	62	27				
300WQ800-9-37		23	21	19	16	13.5	11.5	9	6.2	2		
300WQ800-12-45			24	23	20.5	18	15	12	9	4		
300WQ600-20-55			24.5	23	21.3	20	18	15	11	8		
300WQ800-20-75		30.5	29	27.5	25.8	224	22	20	17	14	8	
300WQ800-26-90		37	35.5	33.8	32	30	28	26	22.5	16	3	
300WQ800-32-110		44	42.5	41	40	39.5	35.5	32	29.5	27	22	
300WQ1000-45-250		60	59	58	57	56	55	54	52	48	20	
300WQ1000-63-315		71	70	69	68	67	66	65	64	63	60	54

Model	Q(m³/h)	200	300	400	500	600	700	800	900	1000	1100	1200
300WQ800-37-132	H (m)	47	46	45	43	41	39	37	33	29	18	
300WQ800-40-160		52	51	50	47.5	45	42.5	40	36	32	22	
300WQ900-40-185		58	55	52.5	50.5	48	45	42.5	40	37	12	
300WQ900-45-200		63	60	57.5	55.5	53	50	47.5	45	42	17	
350WQ1000-6-30					11	10	9	8	7	6	5	3.5

Model	Q(m³/h)	700	800	900	1000	1100	1200	1300	1400	1500	1600	1700
350WQ1200-6-37	H (m)	11	10	9	8	7	6	4.5	2.5			
350WQ1100-7-45		14	13	11	9	7	5	2.5				
350WQ1200-8-45		13.5	12.7	12	11	9.5	8	6	4.5	2.3		
350WQ1100-10-55		15.5	14.5	13	11.8	10	8	6	3.8	2		
350WQ1200-13-75		22.5	21	19.3	17.5	15.5	13	7.5				
350WQ1200-17-90		22.1	21.5	21	19.7	18.3	17	15.5	14	12	10	
350WQ1000-23-110		29	27	25	23	21	19	13				
350WQ1500-16-110		21	20	19.5	19	18.5	18	17.5	16.7	16	15	14
350WQ1100-30-132		36	34.8	33.3	32	30	27	18.5				
350WQ1500-18-132			22	21.5	21	20.5	20	19	18.5	18	17	16
350WQ1500-26-160			34.7	33.5	32.5	31.5	30	28.7	27.5	26	24.7	23.5
350WQ1200-30-185		37.5	36.8	35	33	31.5	30	28	24	18		
350WQ1500-35-250		47	45.5	44	42.5	41	39.5	38	36.5	35	31	27
350WQ1500-45-315		57	55.5	54	52.5	51	49.5	48	46.5	45	42	39
400WQ1000-8-37		11	10	9	8	6.8	5.5	4.3	3	1.5		
400WQ1200-8-45		13.5	12.7	12	11	9.5	8	6	4.5	2.3		
400WQ1200-10-55		15.5	14.7	14	13	11.5	10	8	6.5	4.5		
400WQ1500-10-75		18.5	17.5	16.8	15.5	14.5	14	12.2	11	10	8	

Model	Q(m³/h)	900	1050	1200	1350	1500	1650	1800	1950	2100	2250	2400
400WQ1200-15-75	H (m)	17	16	15	12.6	10.7	9	5				
400WQ1500-16-90			21.5	19.5	18	16	13.5	3.5				
400WQ1600-15-110				16.7	16	15.3	14.7	13.4	12	10	8	6
400WQ2000-13-132		22	21	20	19	18	16.5	15	13.3	12	10.5	9
400WQ1500-22-160		31	28.8	26.5	24	22	19.5	10				
400WQ2000-18-160			25	24.5	23.5	22.5	21.6	20.2	18.7	16.8	15.5	8.5
400WQ2000-20-185		30.5	29.5	28.4	27.5	25.5	24	22	20.3	19.5	18	15
400WQ2000-22-200		32	31	30	29	28	26.5	25	23.5	22	20	18
400WQ1500-35-250		44	42	40	37.5	35	32	25				

Model	Q(m³/h)	700	1000	1300	1600	1900	2200	2500	2800	3100	3400	3700
500WQ1800-12-90	H (m)	18.5	17	15.5	13.5	11.3	8.8	6	3			
500WQ2500-10-110		16	15.2	14.2	13.2	12.2	11.2	10	8.7	7.1	6	4.5
500WQ2500-12-132		24	23	21	18.8	17	14.5	12	9	7	2	
500WQ2500-13-160		26	24.4	22.5	20.5	18	15.6	13	10	7	3	
500WQ2500-14-185		23.5	22	20.5	19	17.5	15.8	14	12	9.5	7	4
500WQ2500-16-200		25.5	24	22.5	21	19.5	17.8	16	14	11.5	9	6
500WQ2500-18-185		25.5	24.5	23.8	22.5	21	19.5	18	16	13.5	10.5	7.5
500WQ3000-25-315		38.7	37	35.3	33.5	31.8	30	28.2	26.5	24.3	21	18.3

Model	Q(m³/h)	800	1200	1600	2000	2400	2800	3200	3600	4000	4400	4800
600WQ2500-14-185	H (m)	23	21	19	17	15	12	8	4			
600WQ2500-16-200		25	23	21	19	17	14	10.5	6			
600WQ3200-13-185		26	25	23	21	18.8	16	13	9	5		

十七、Performance curve

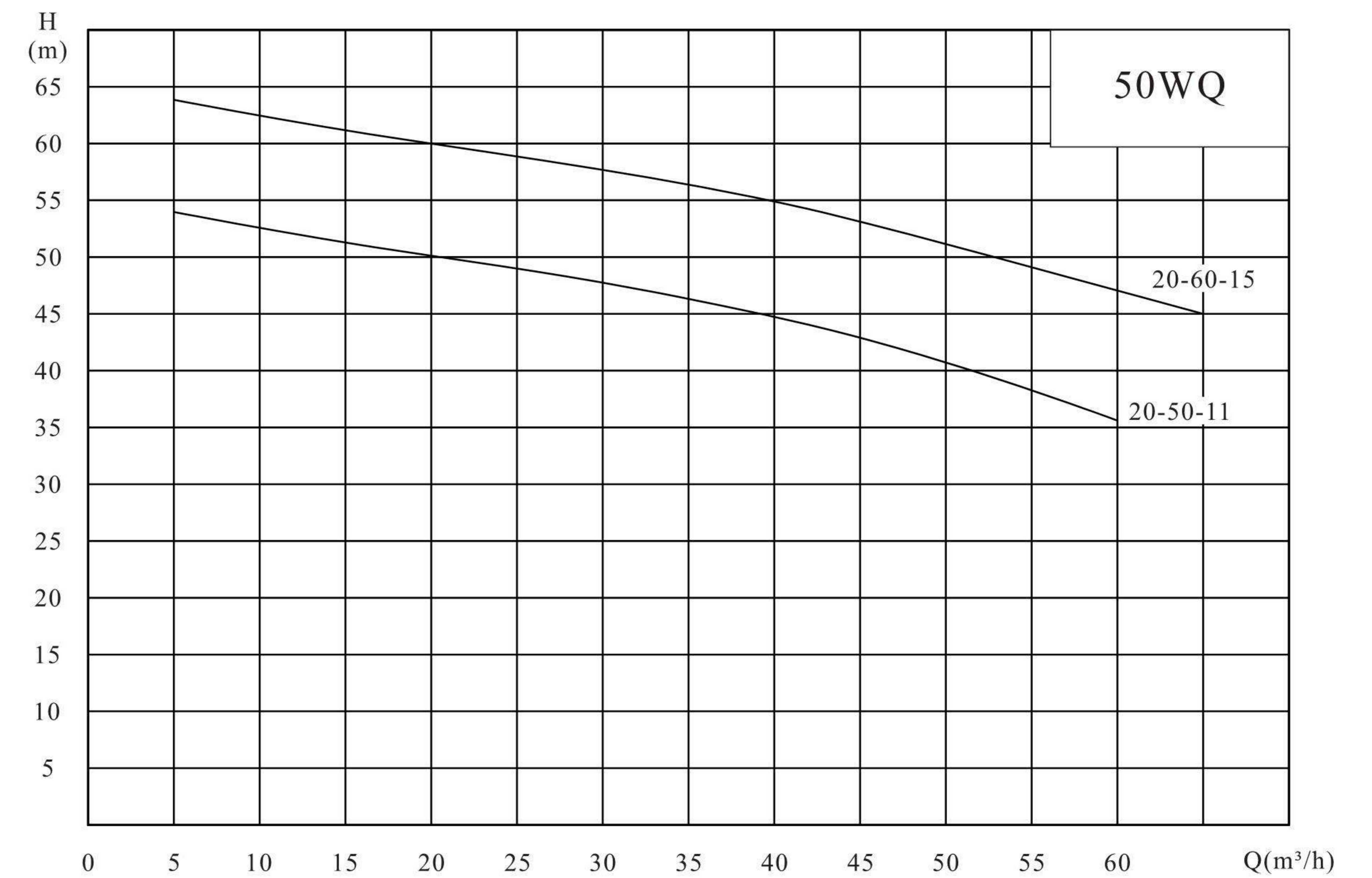
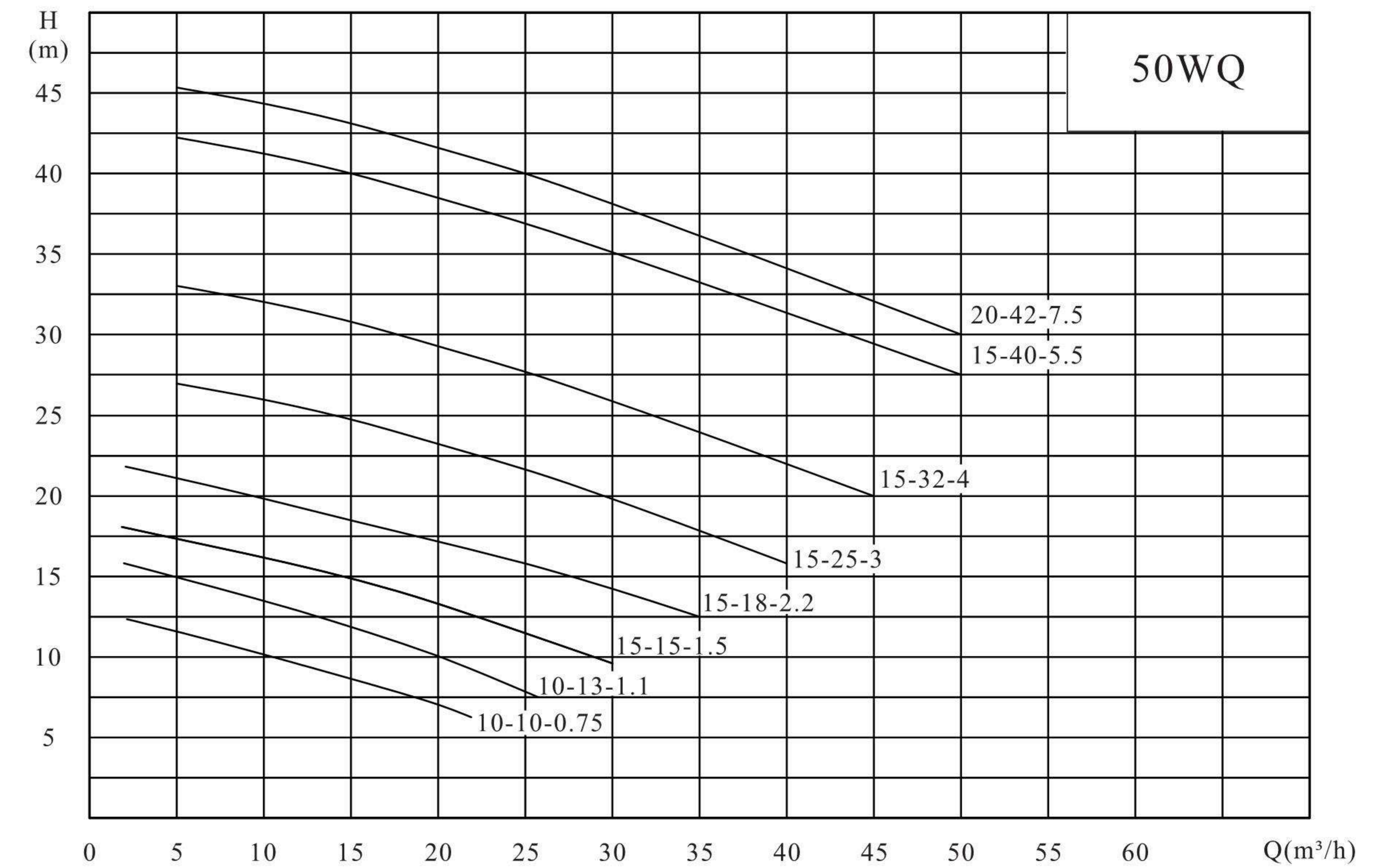

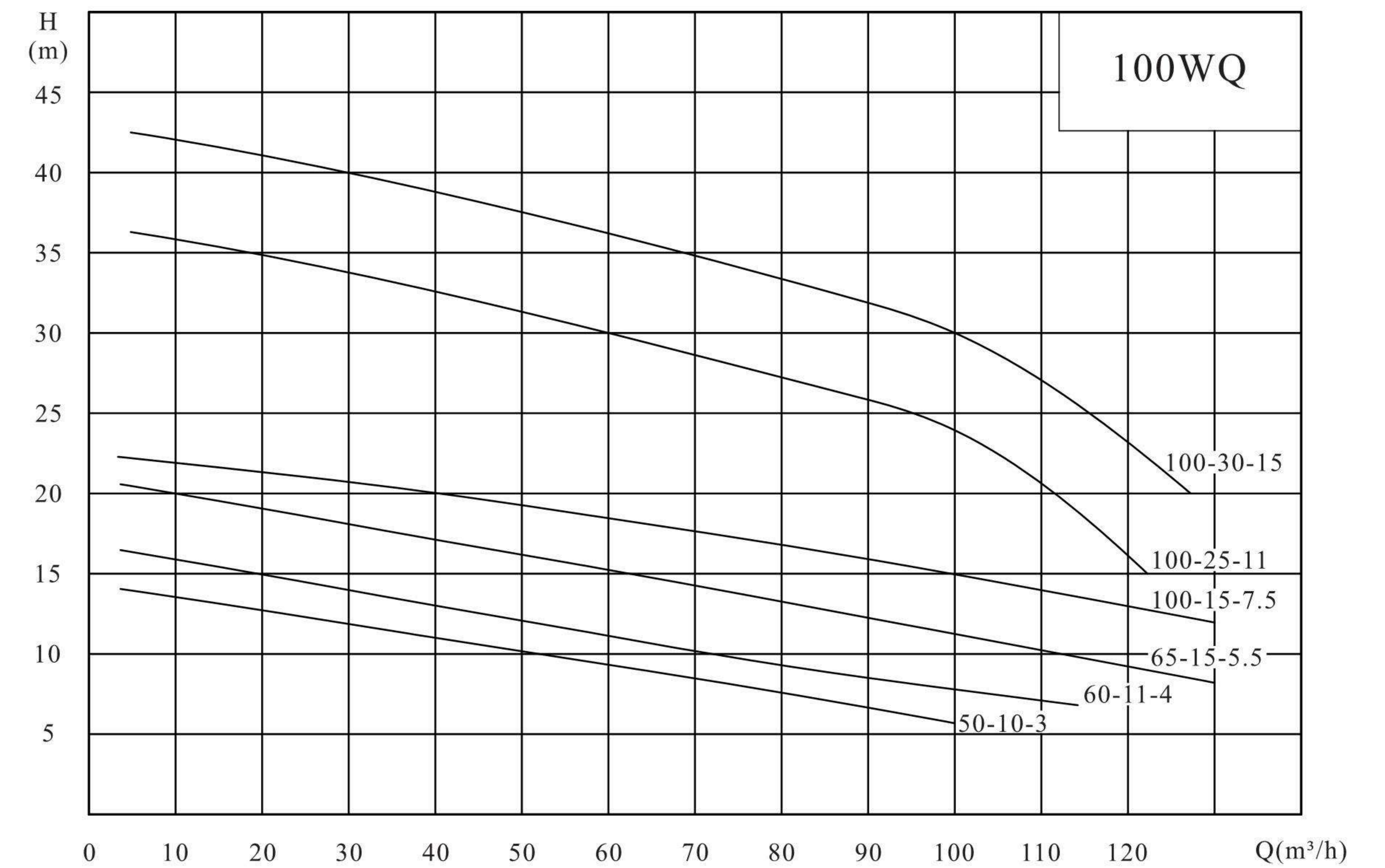
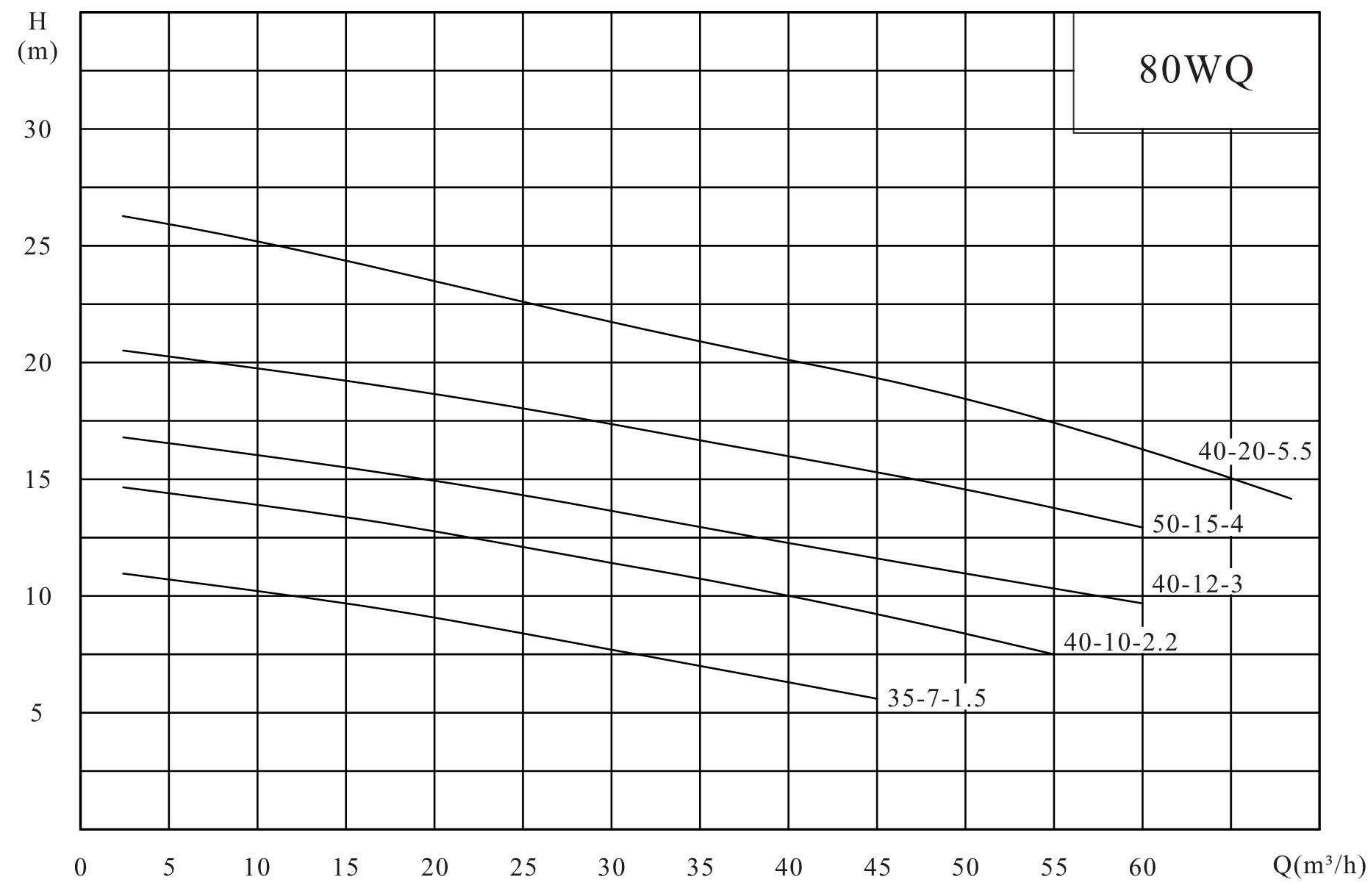
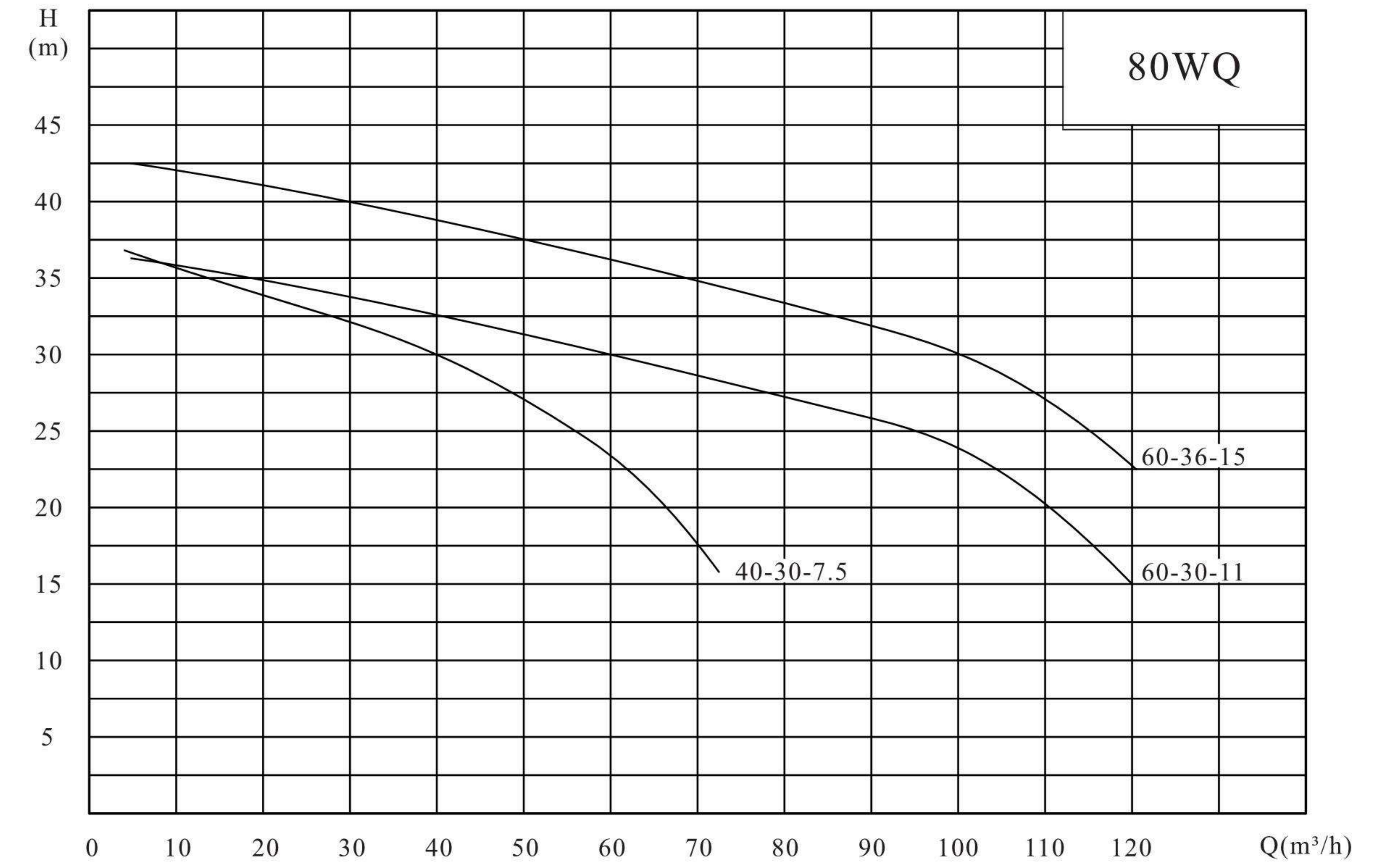
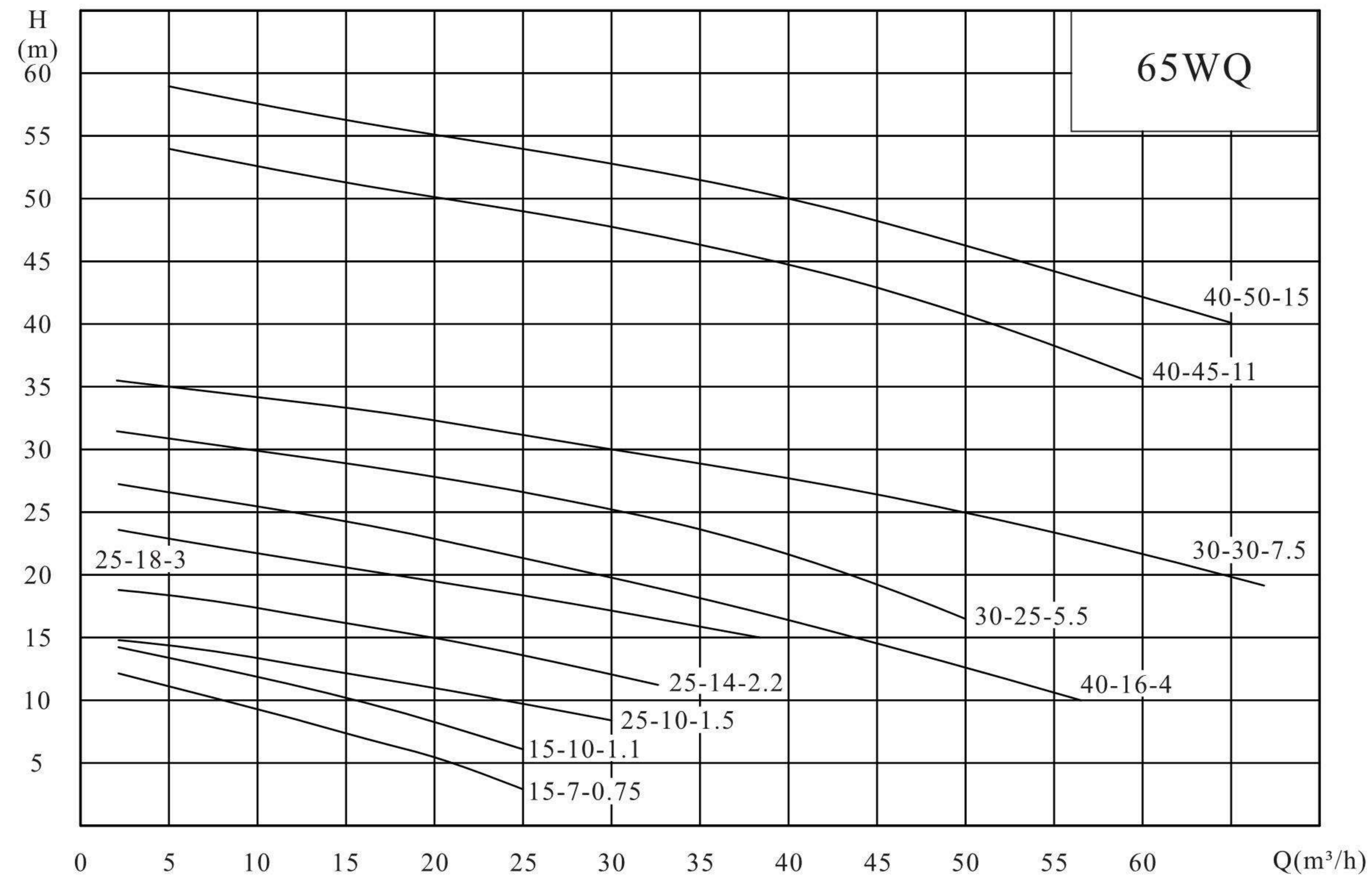

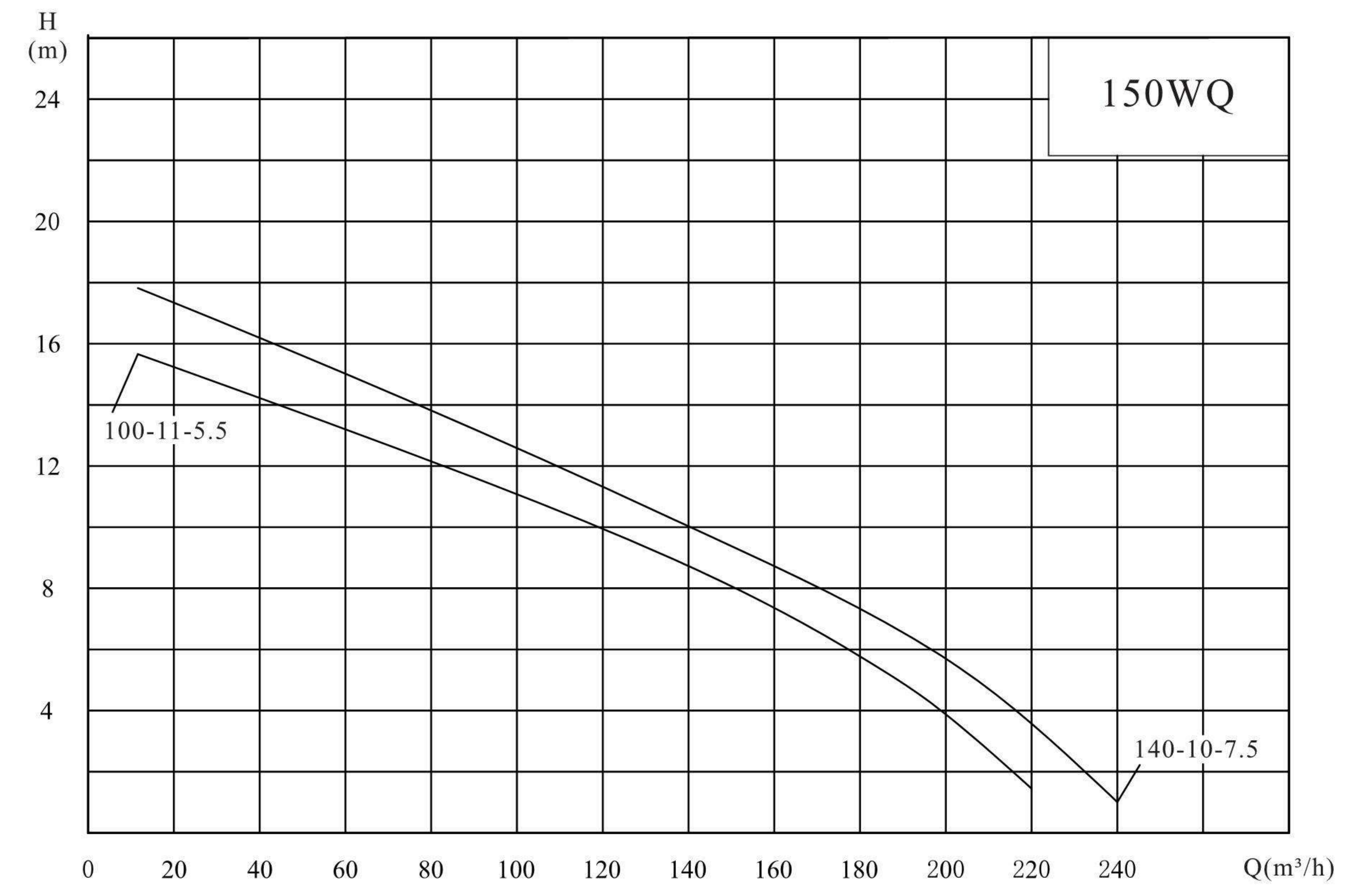
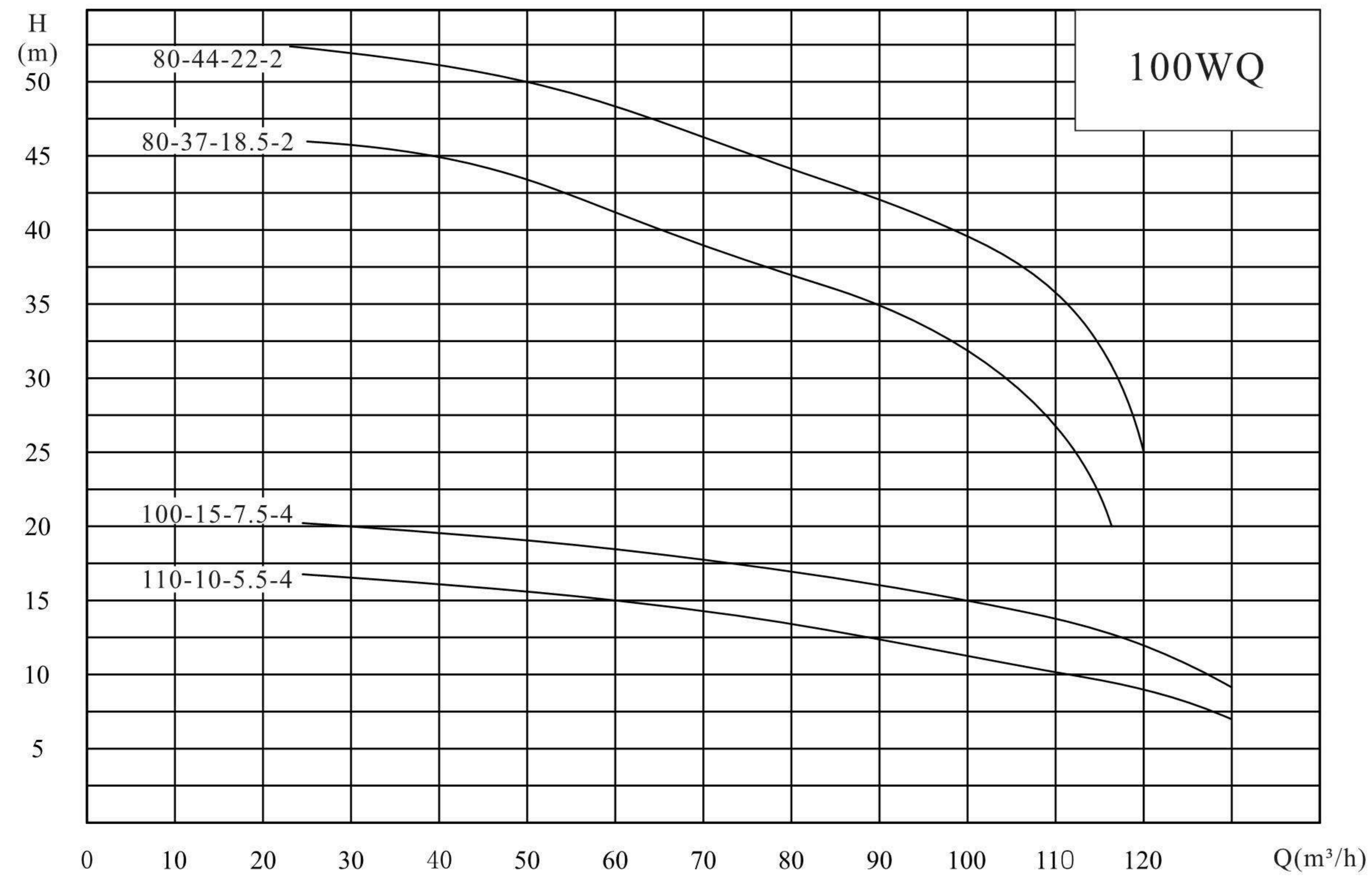
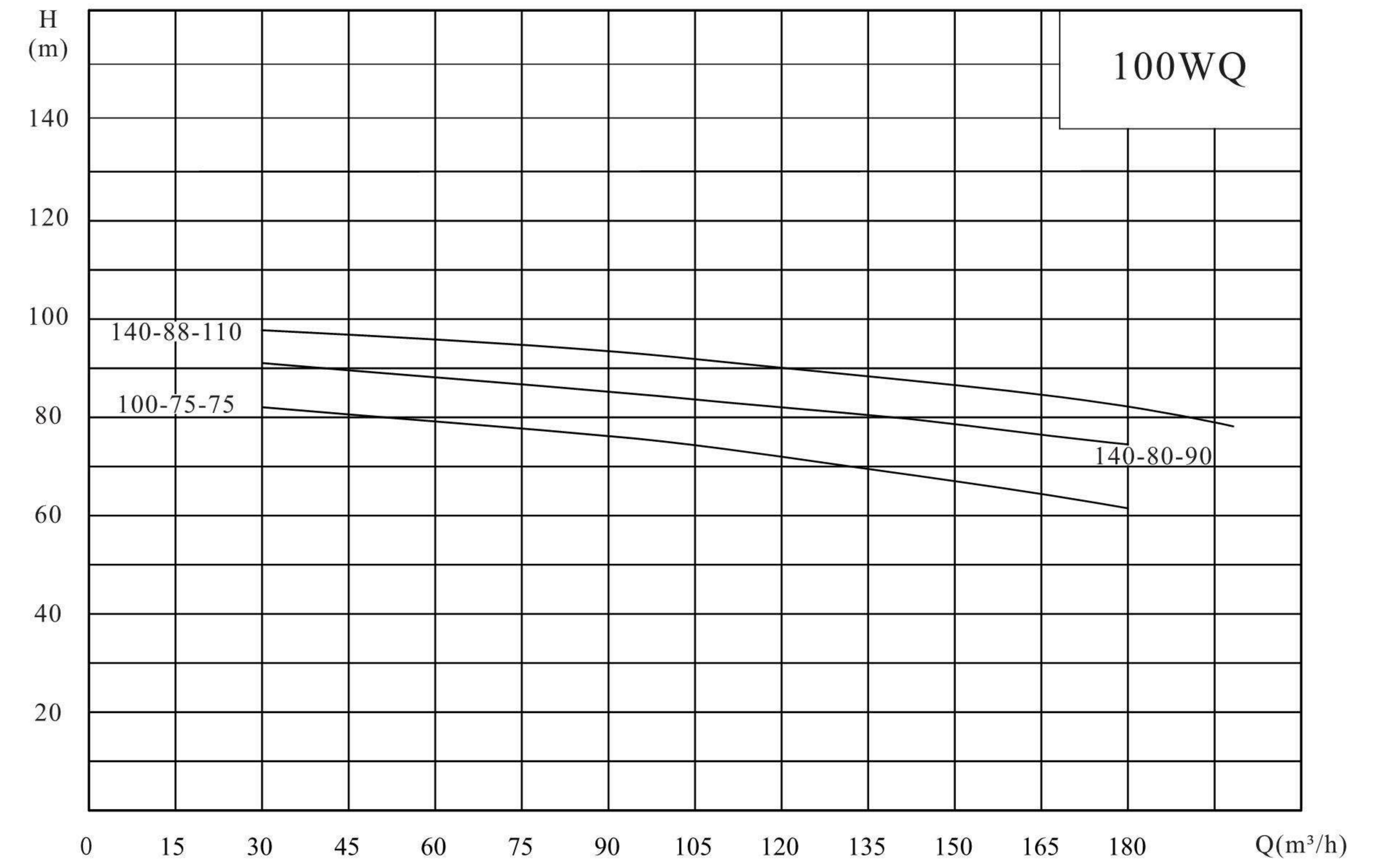
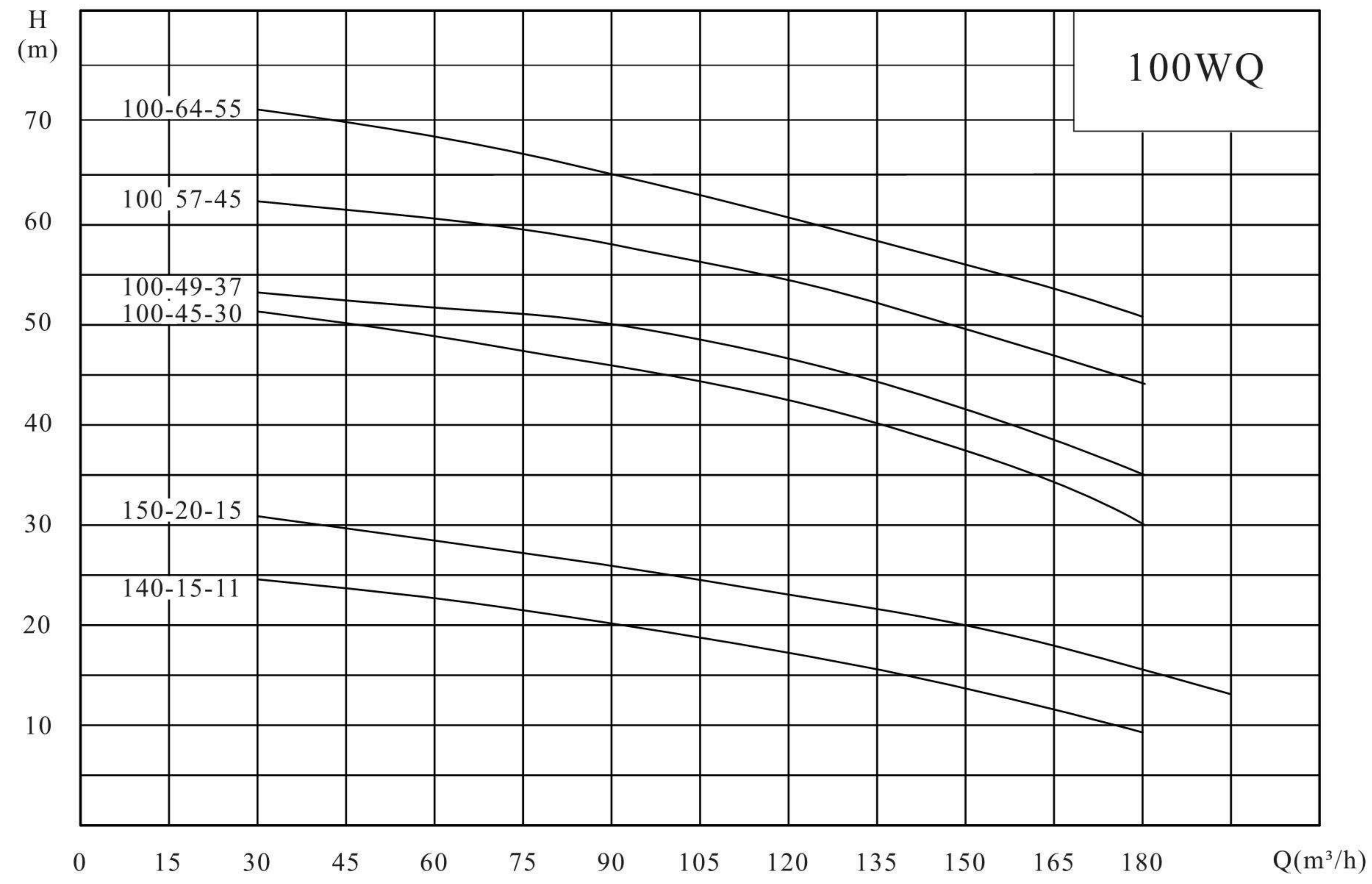

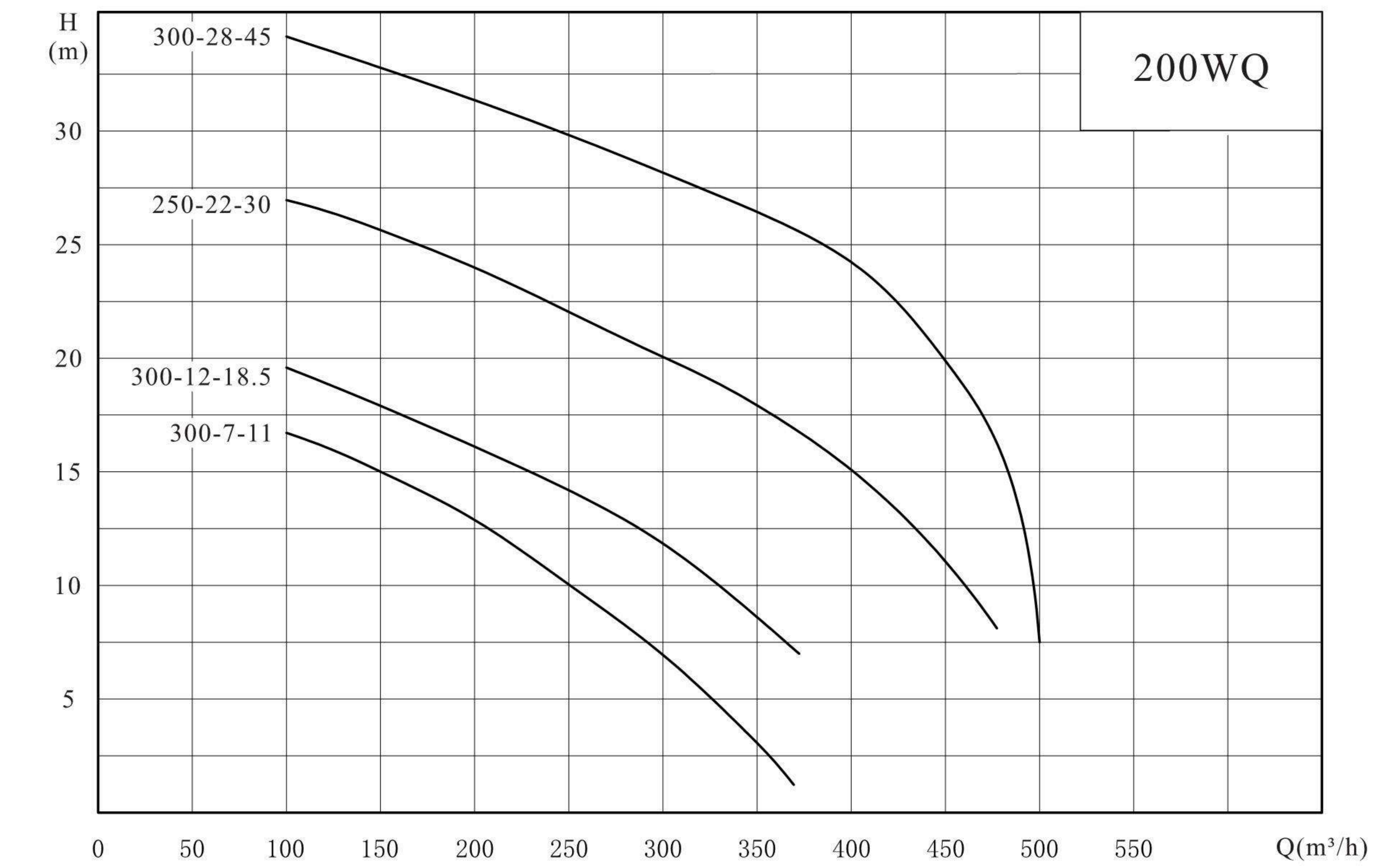
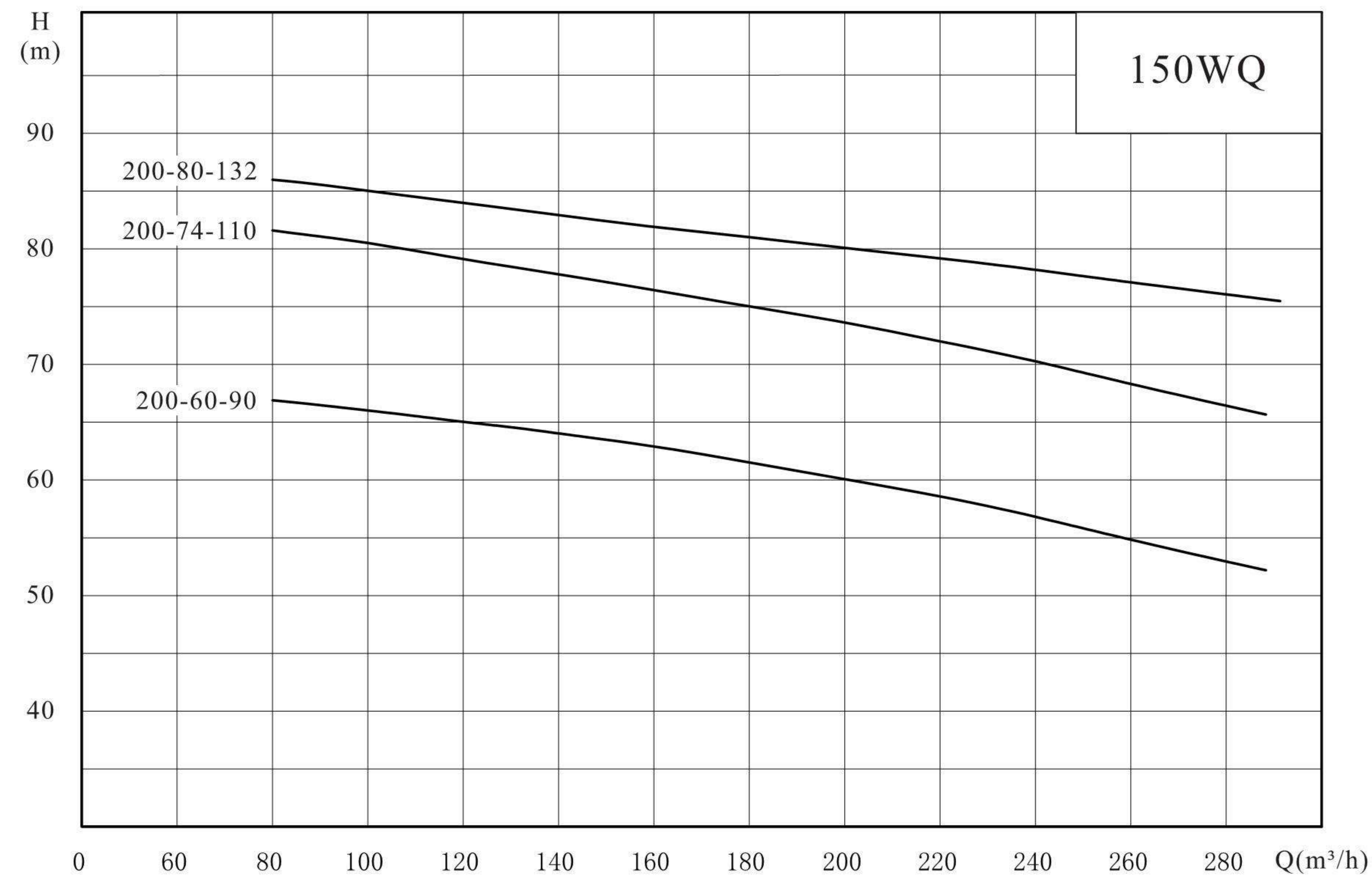
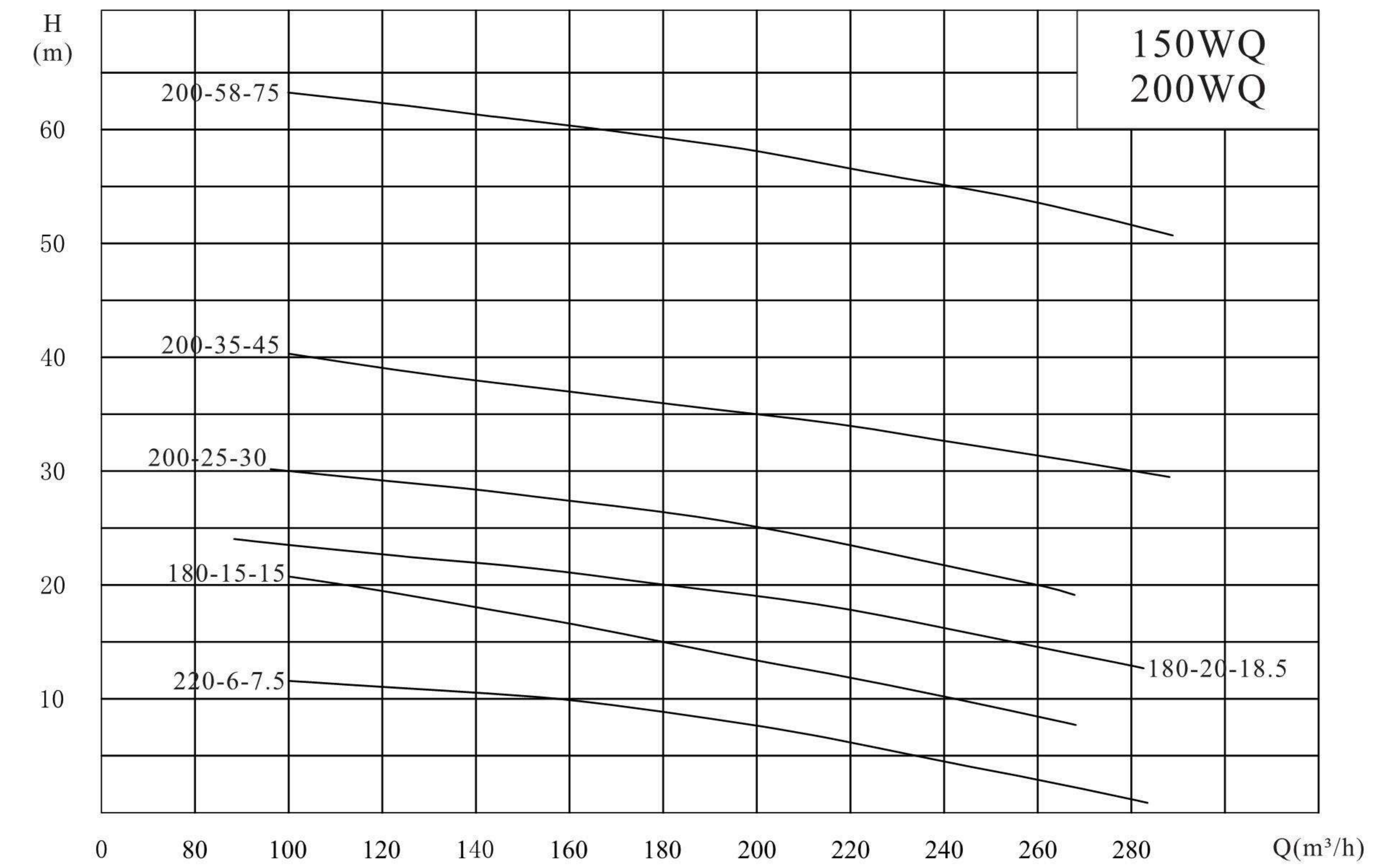
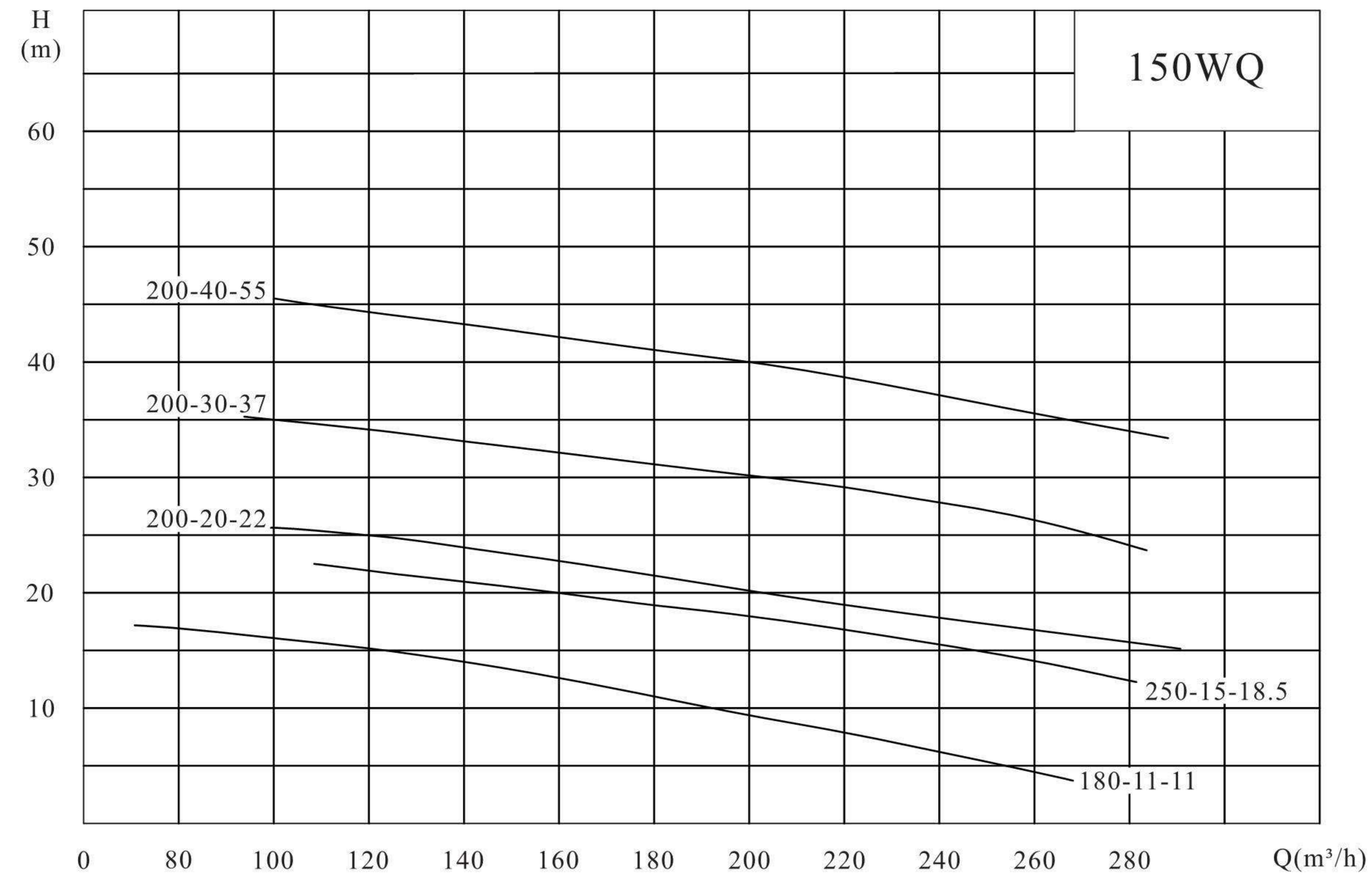

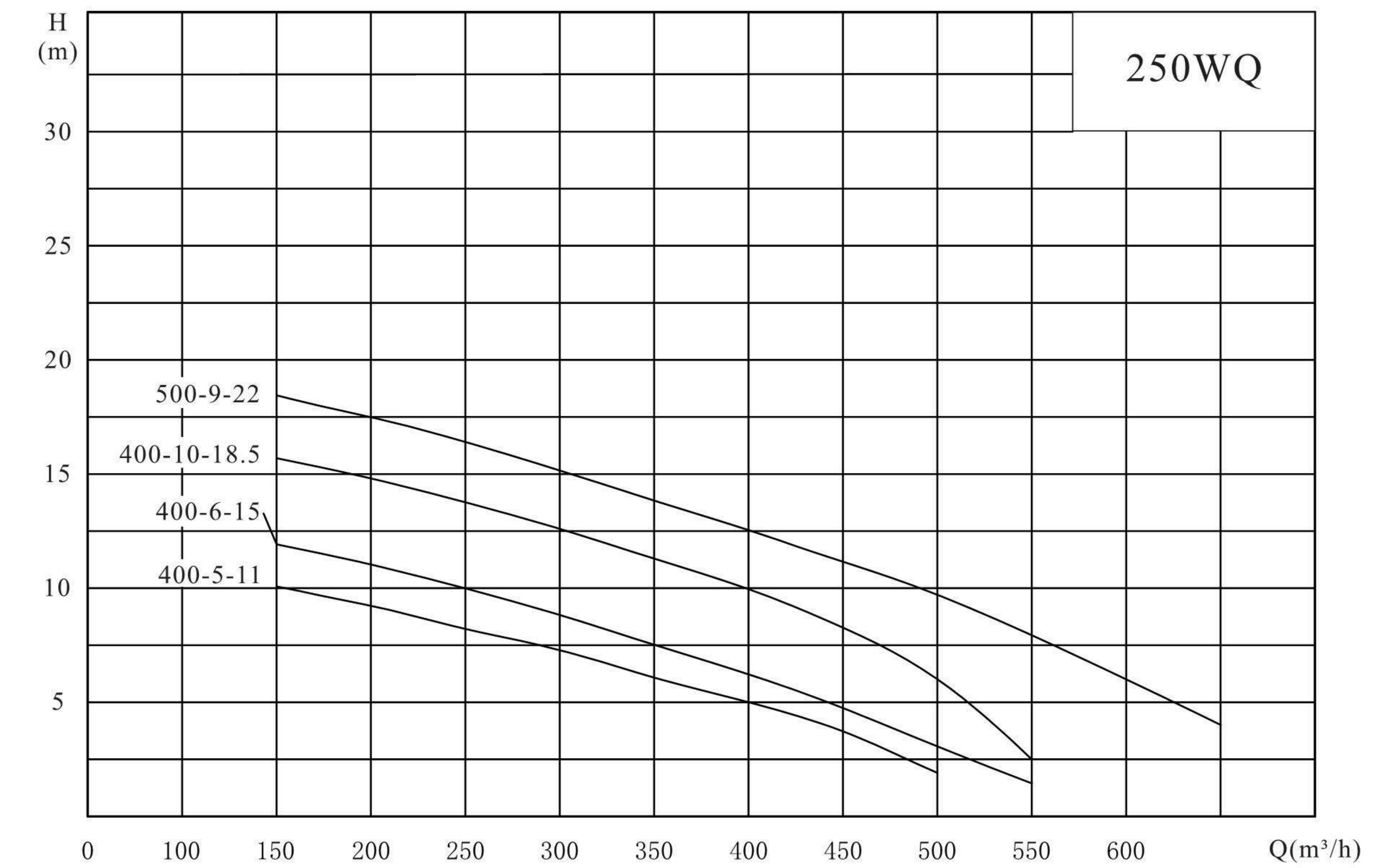
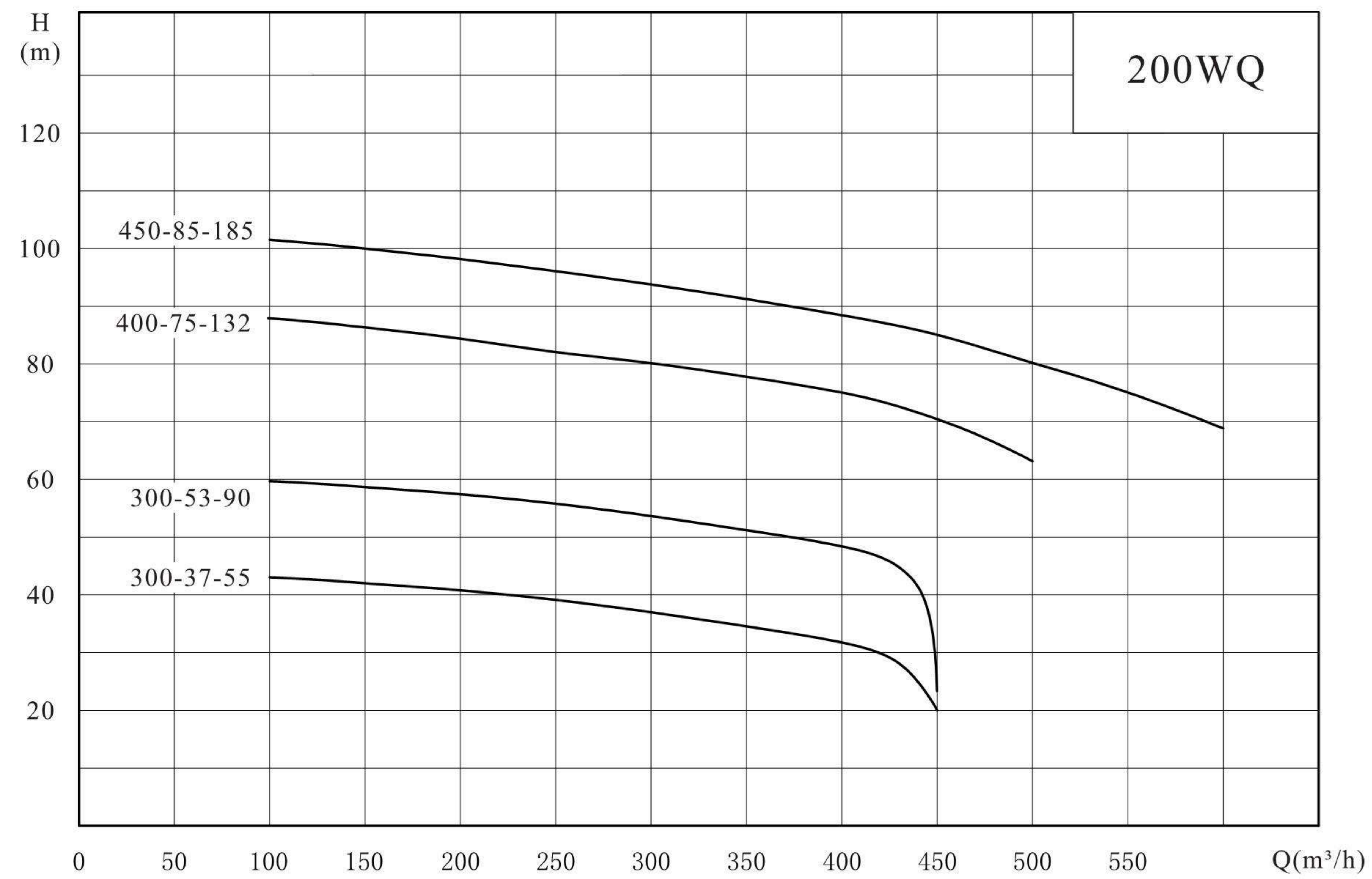
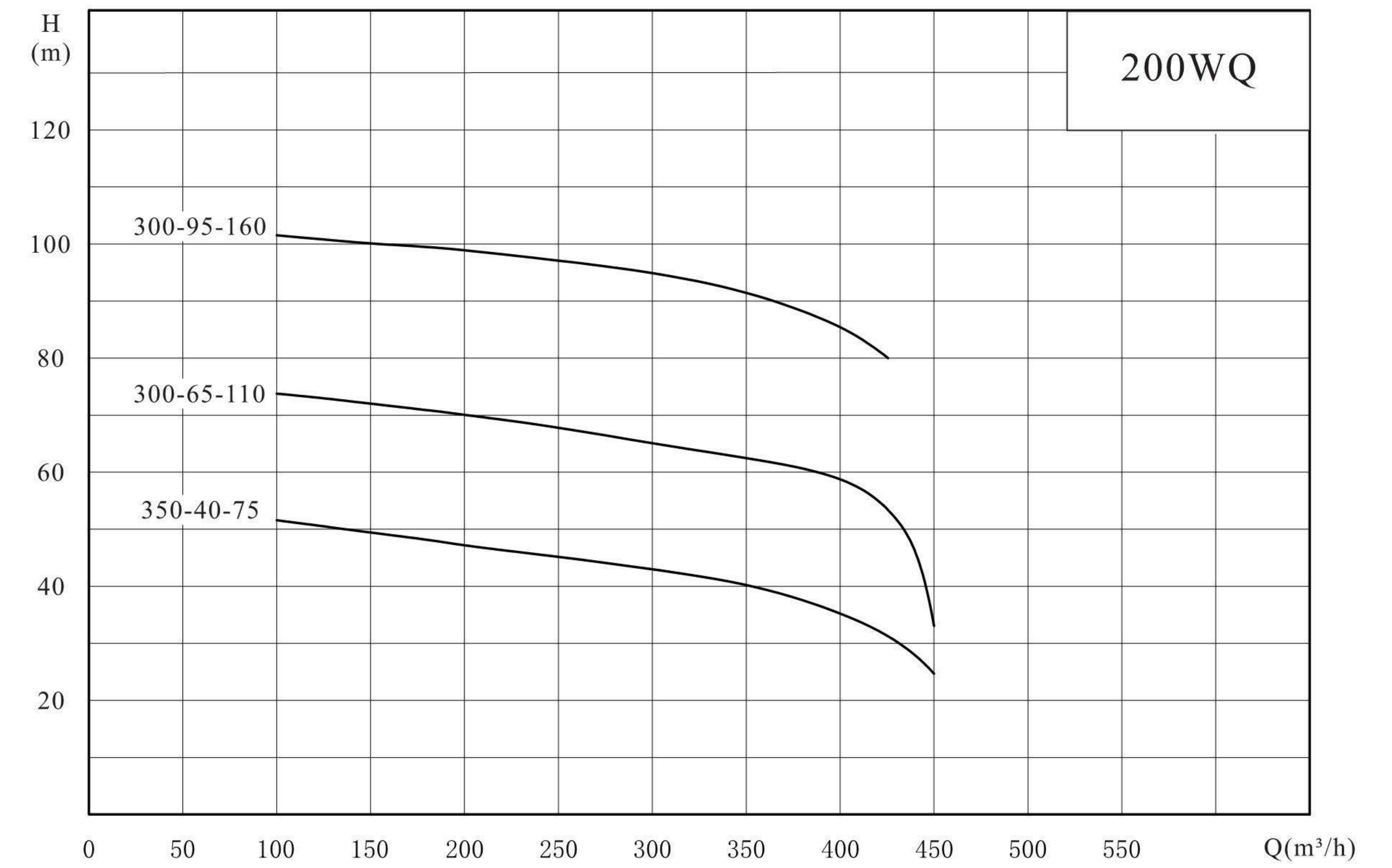
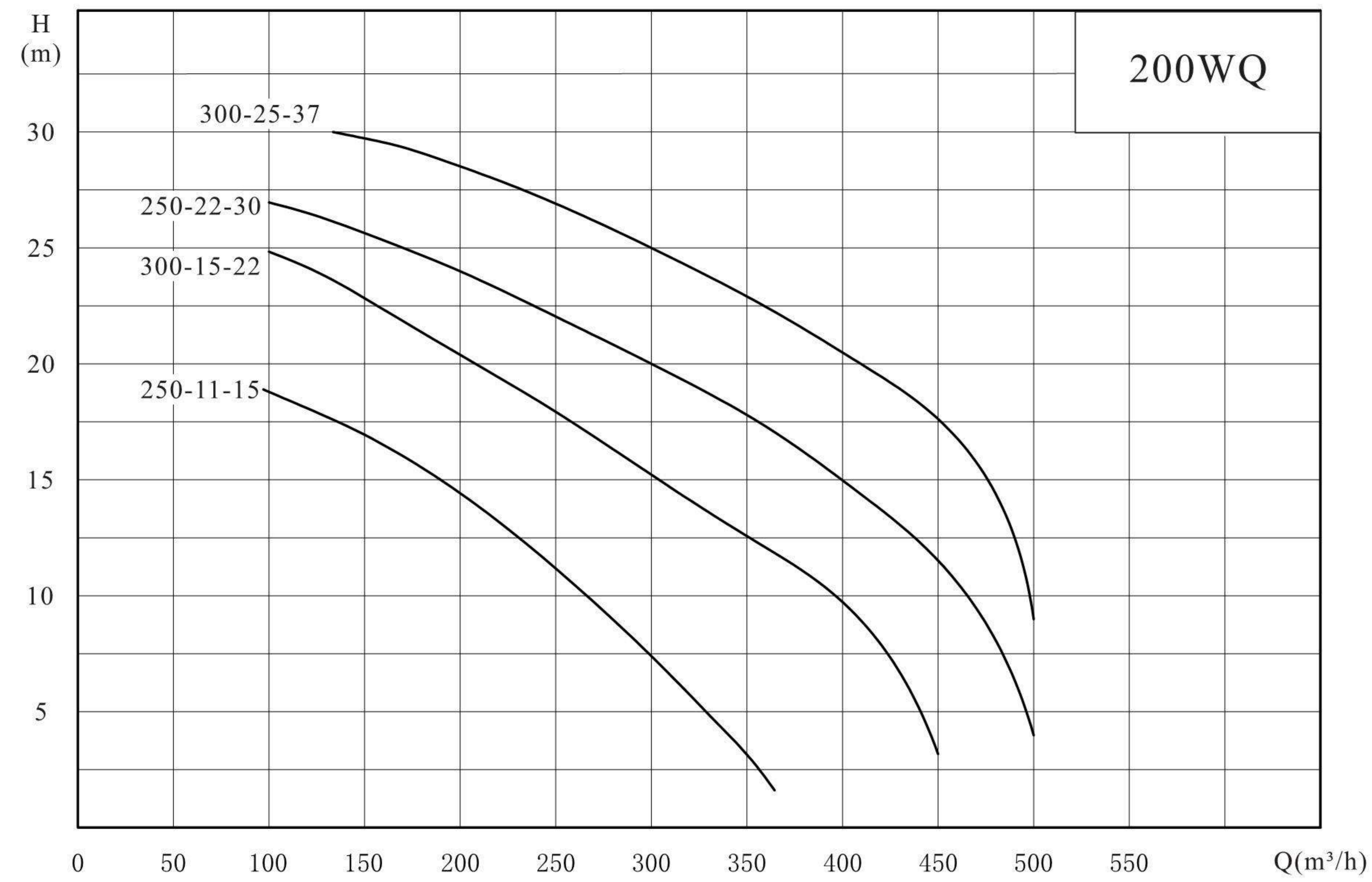

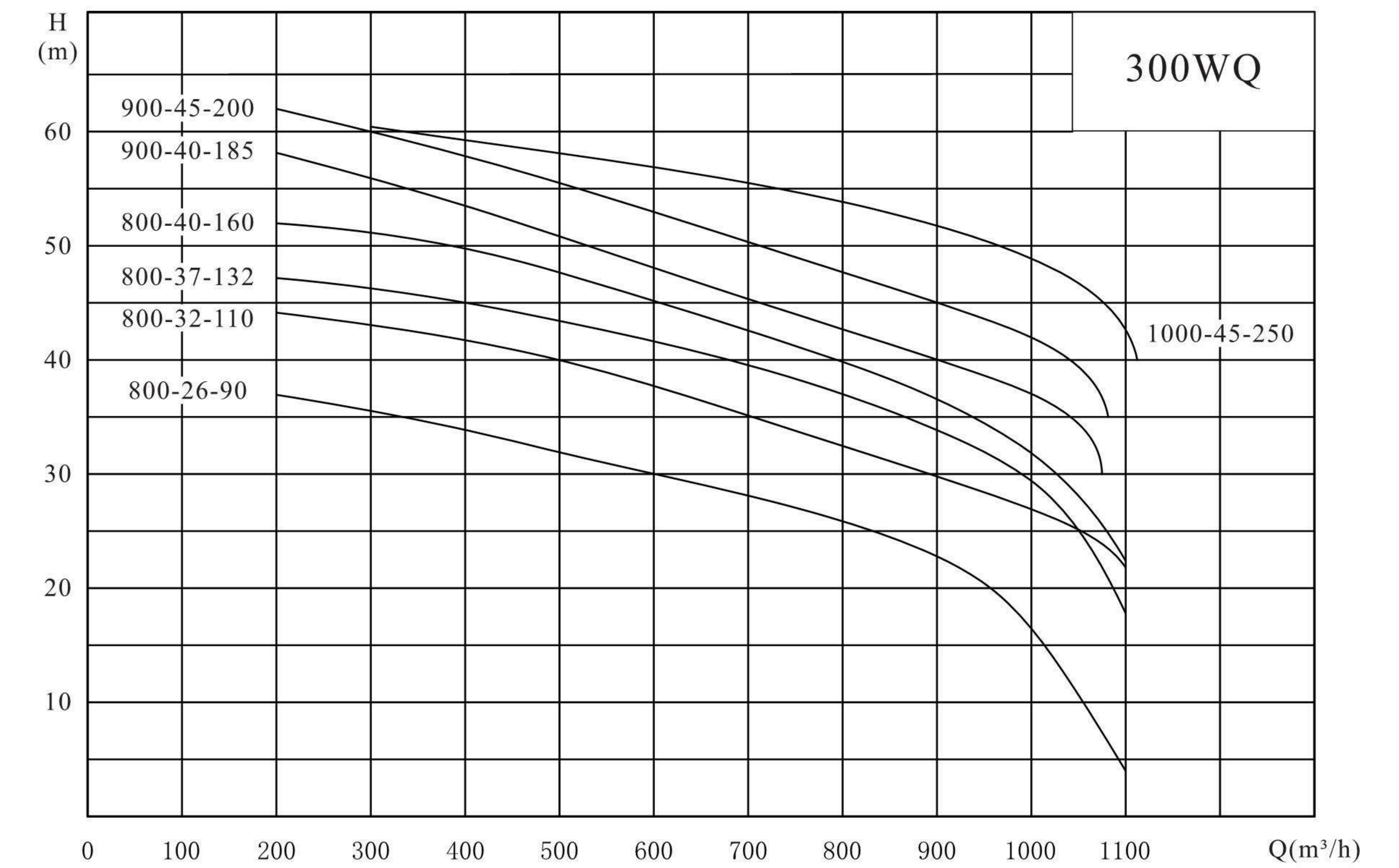
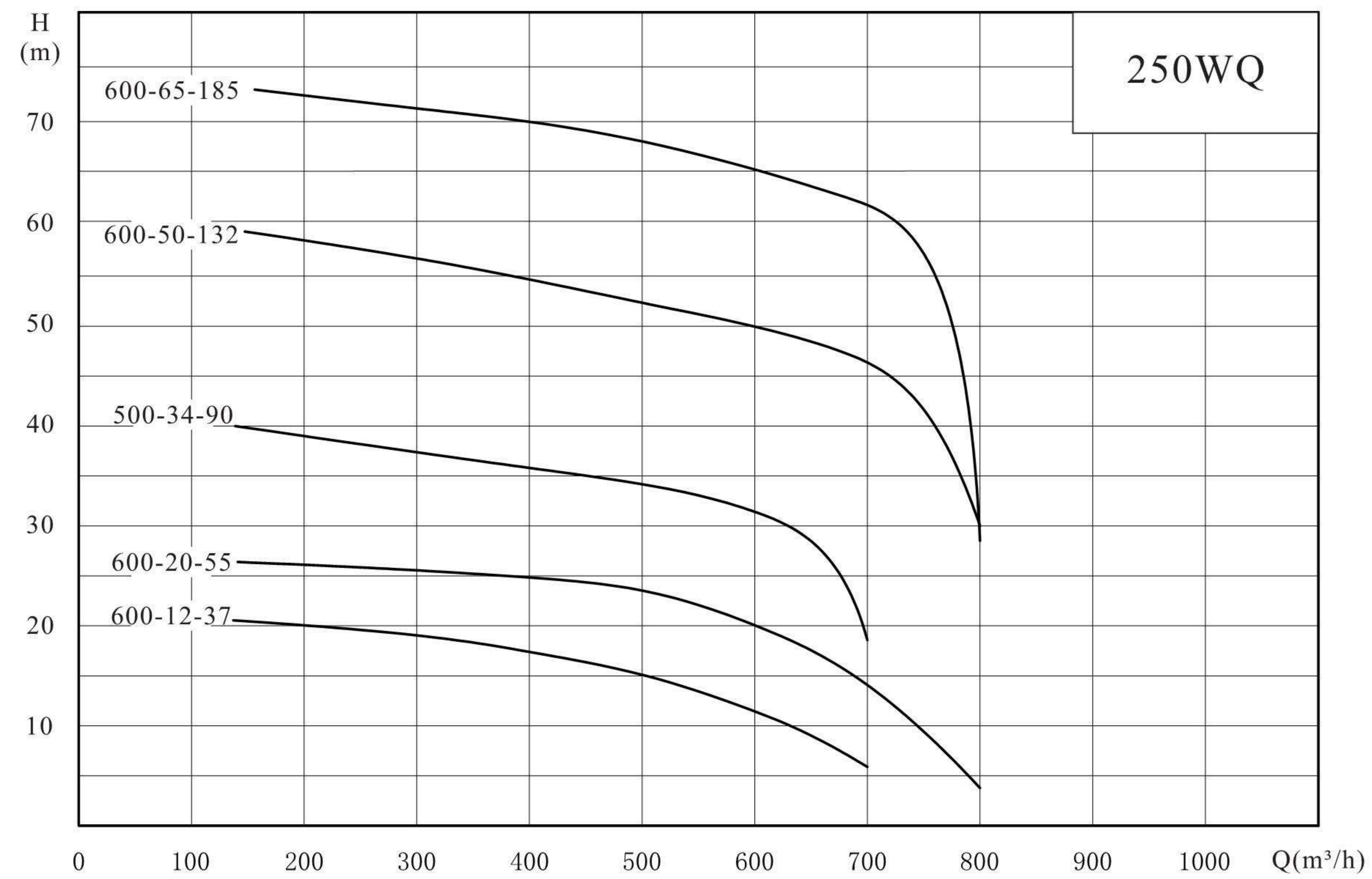
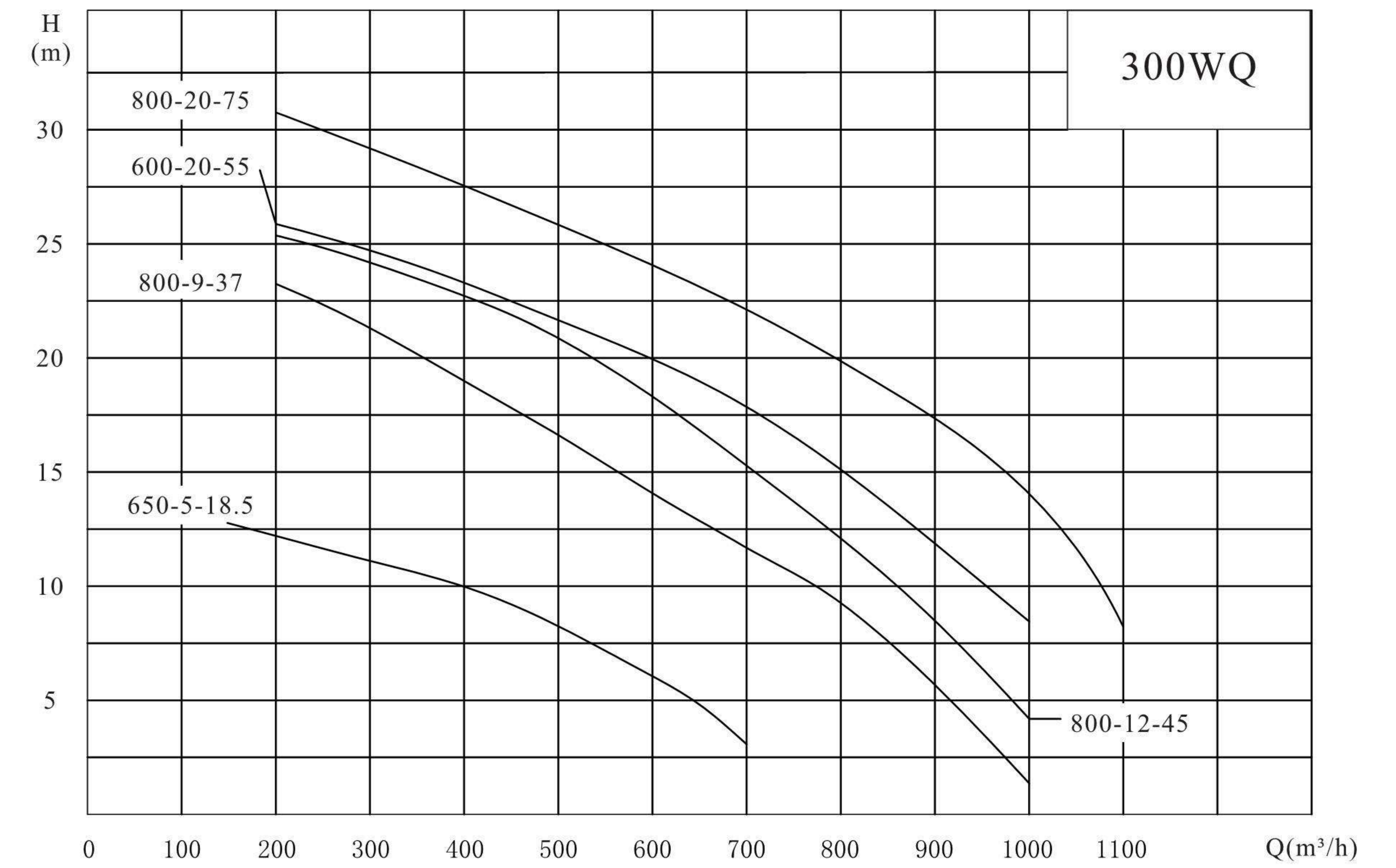
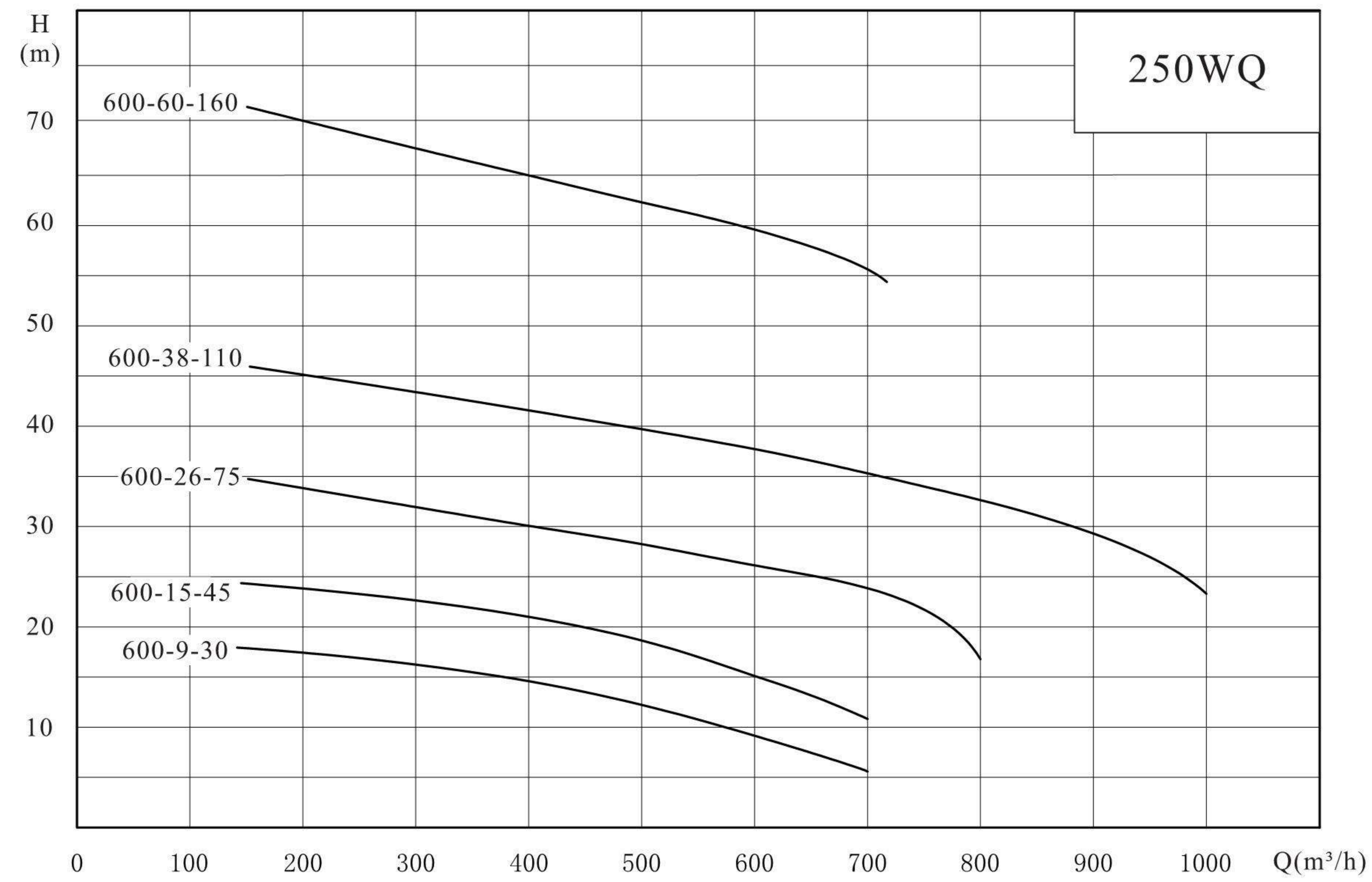

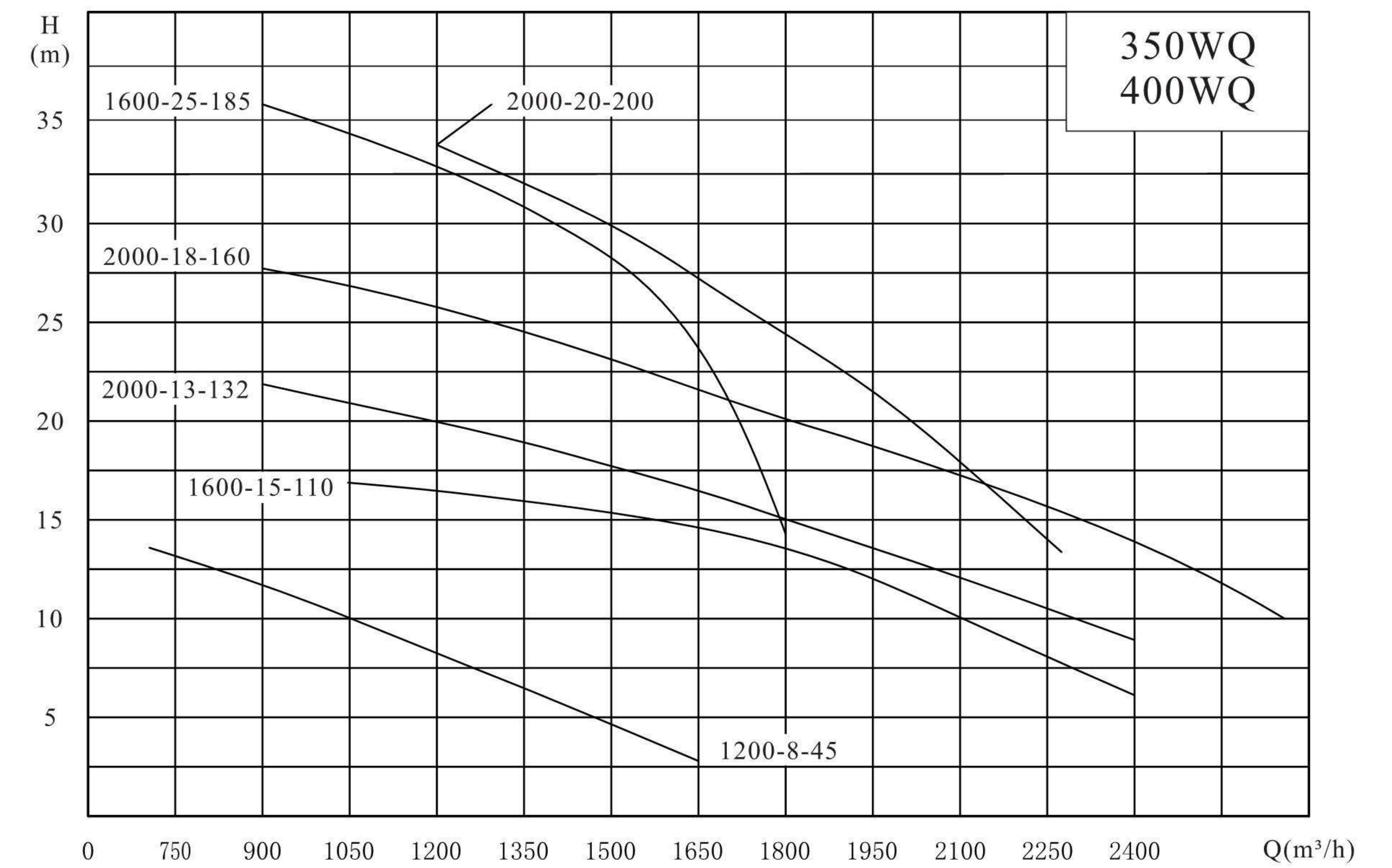
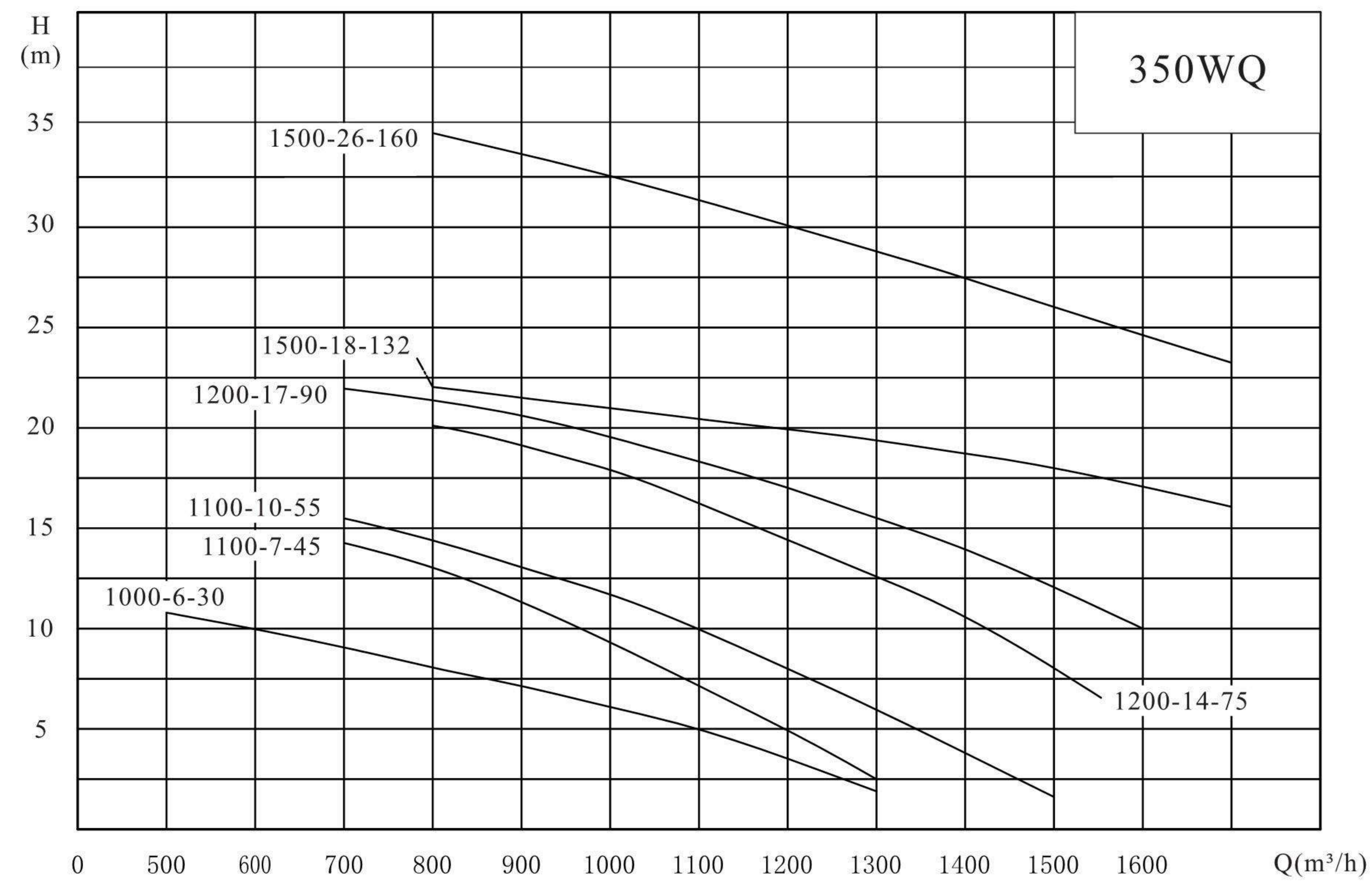
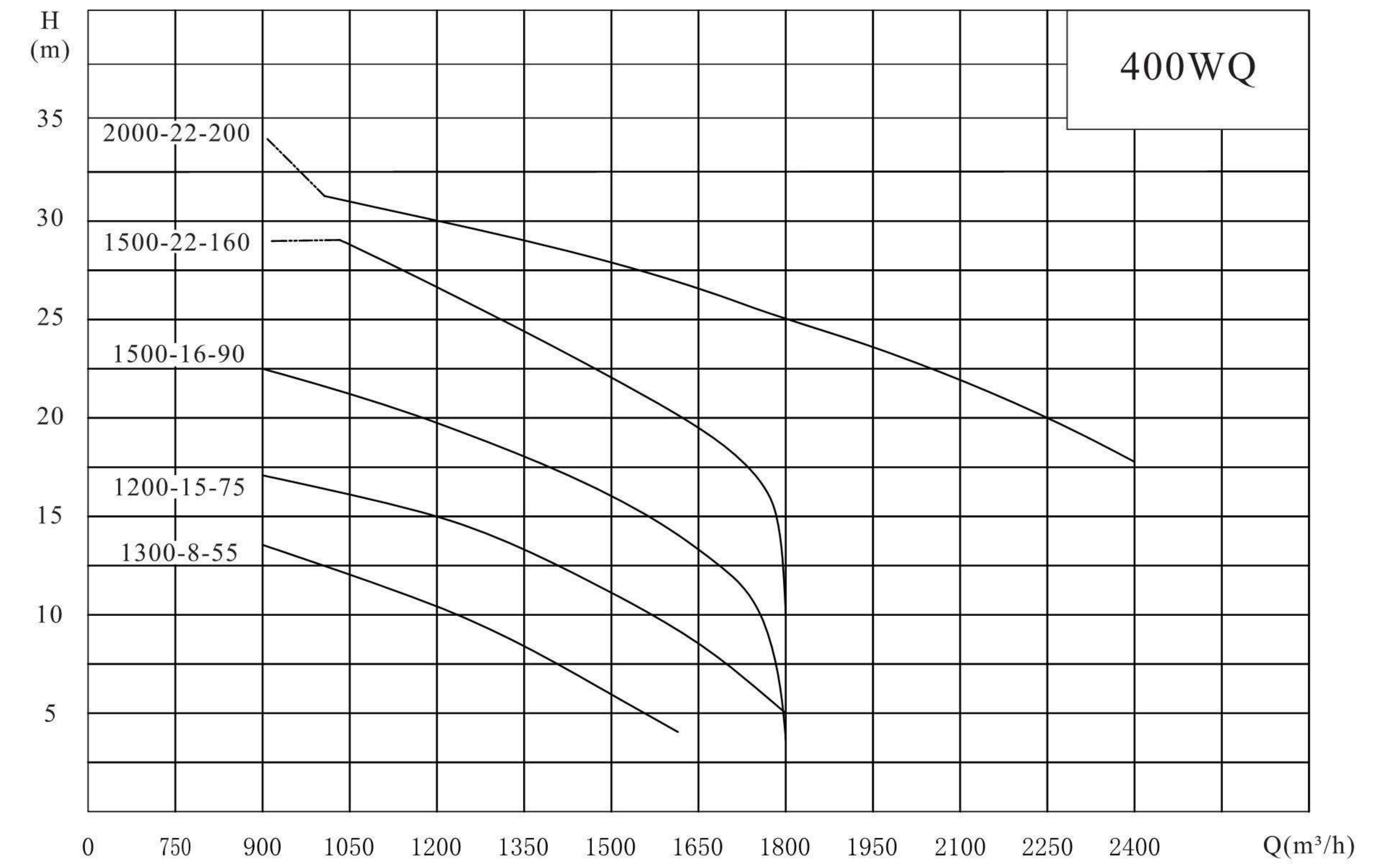
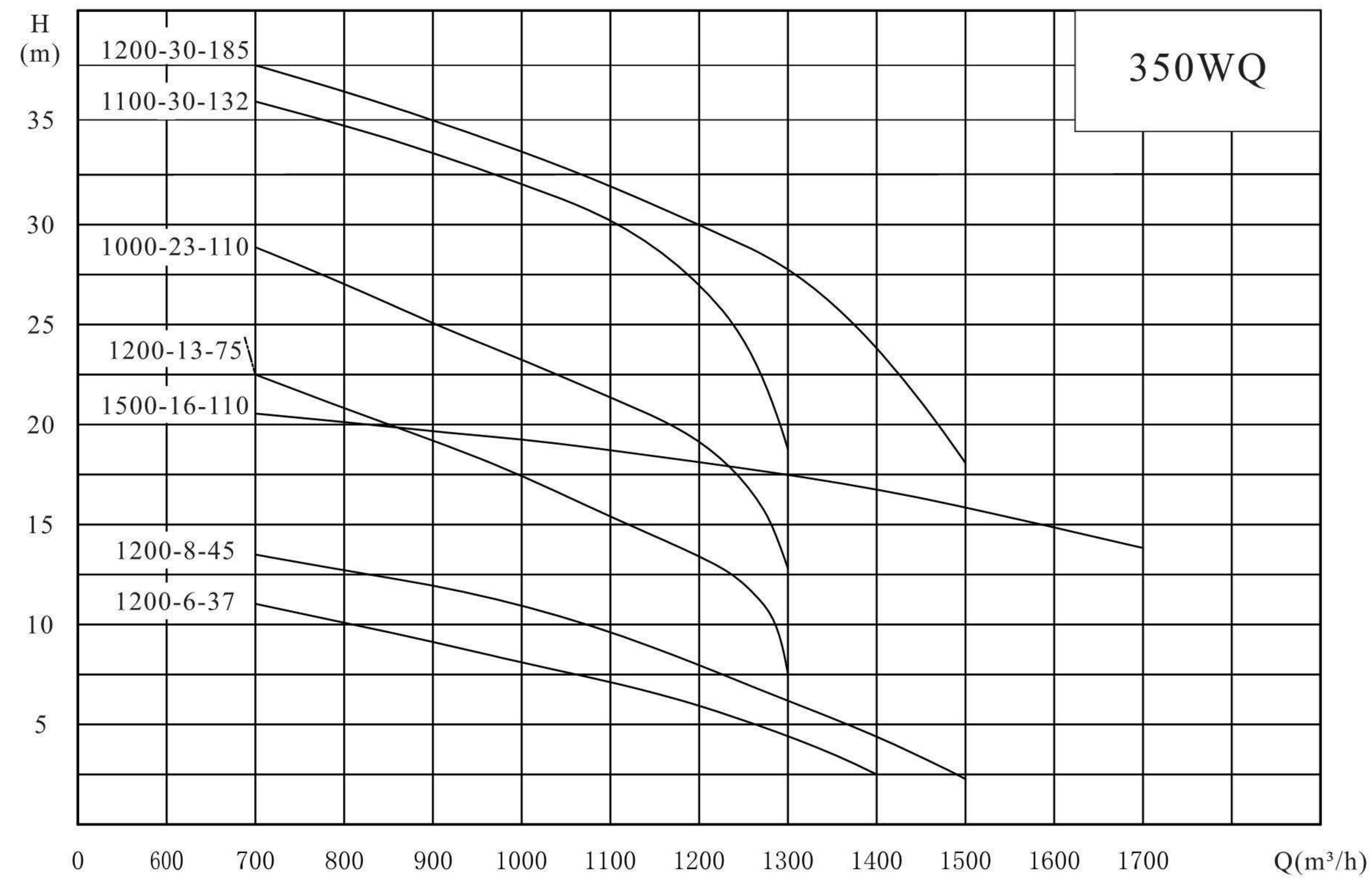

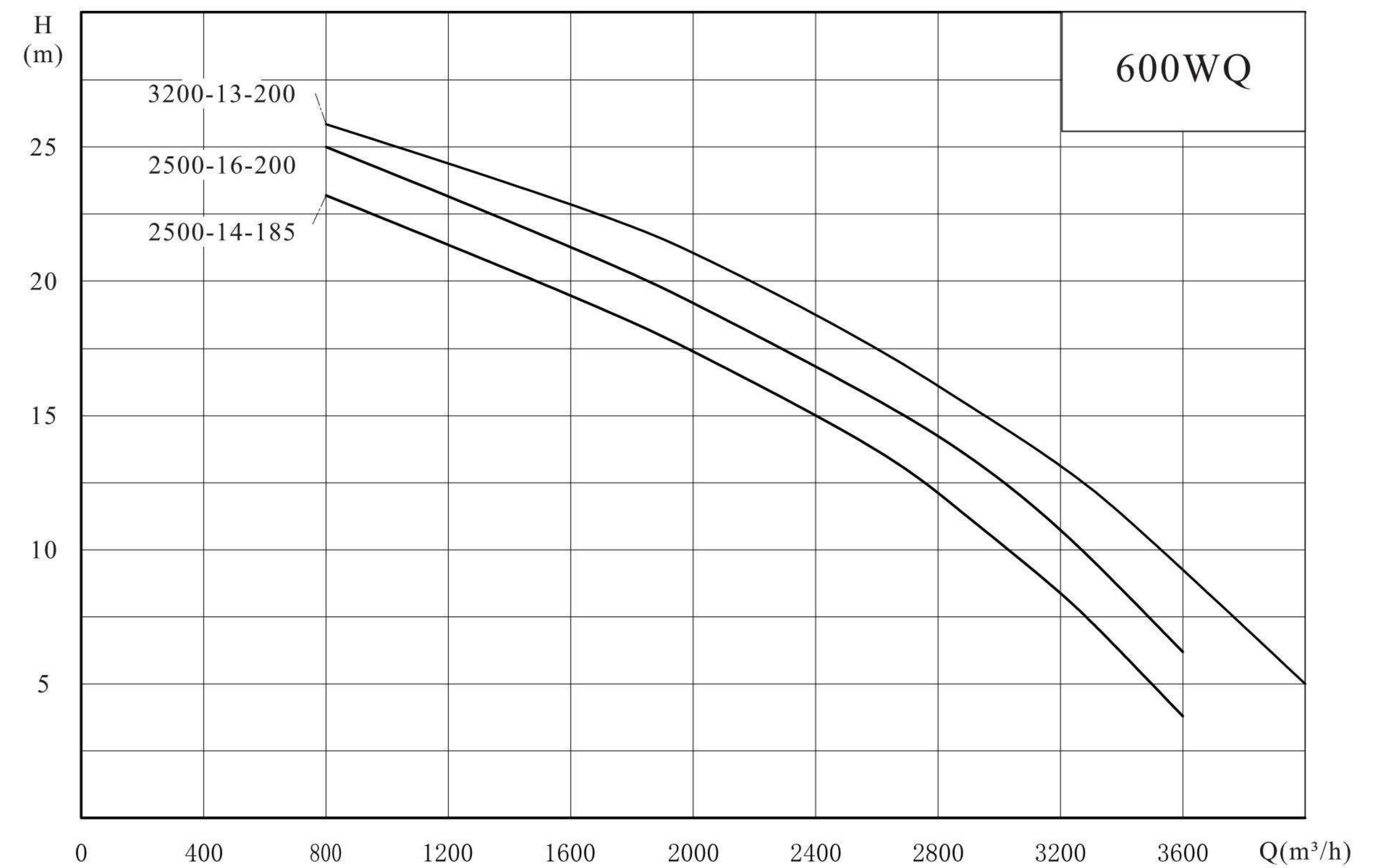
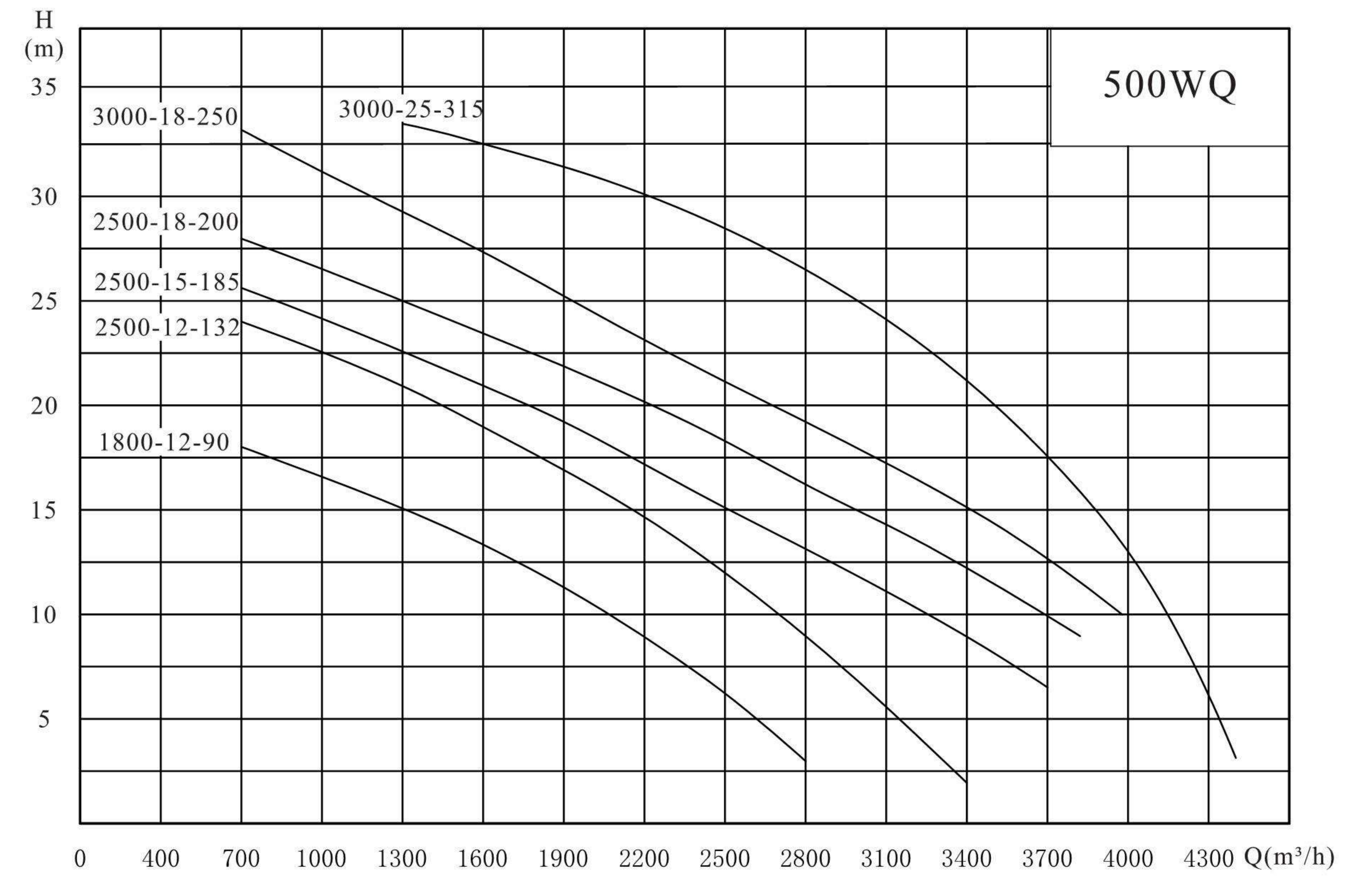
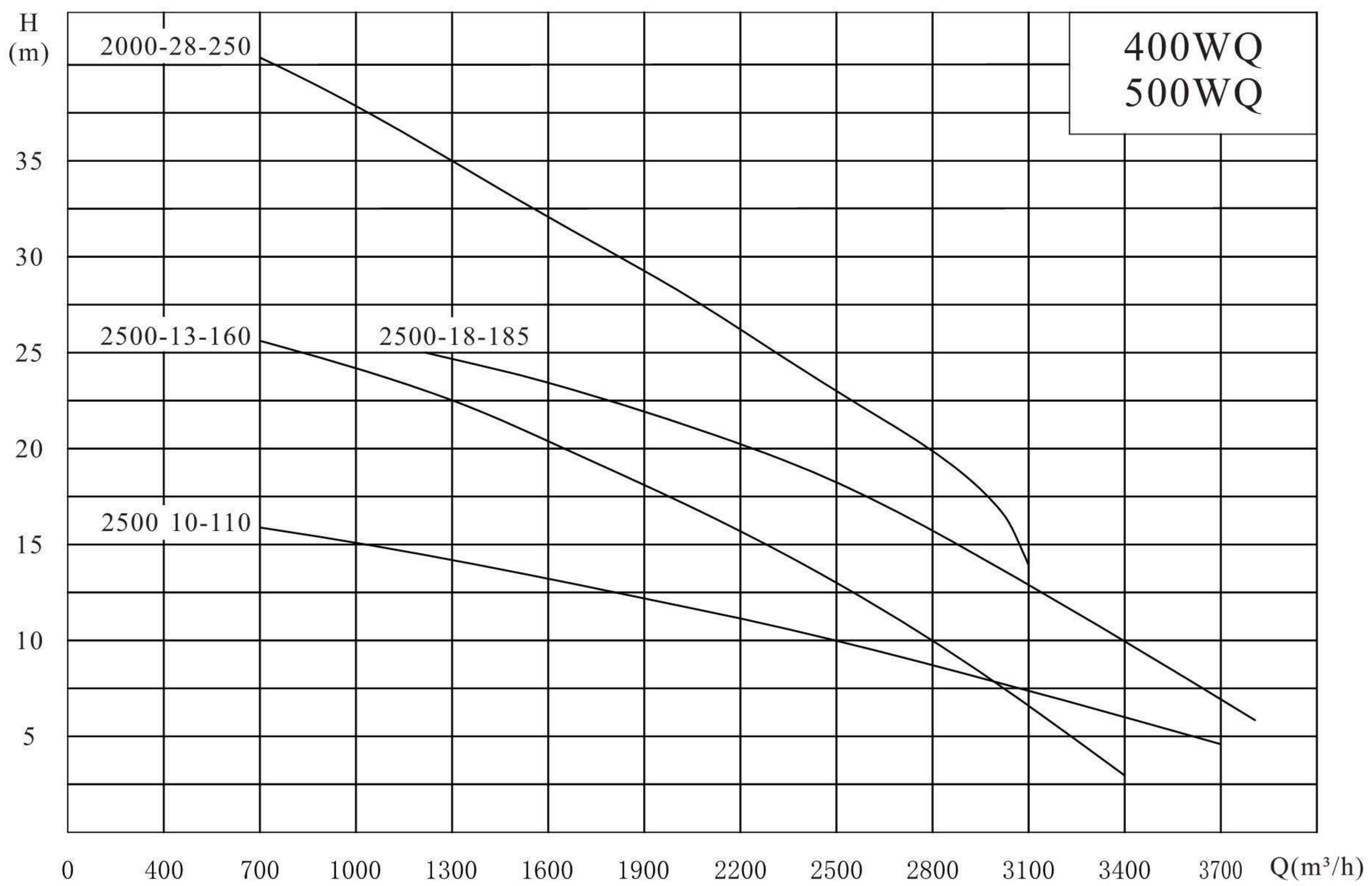
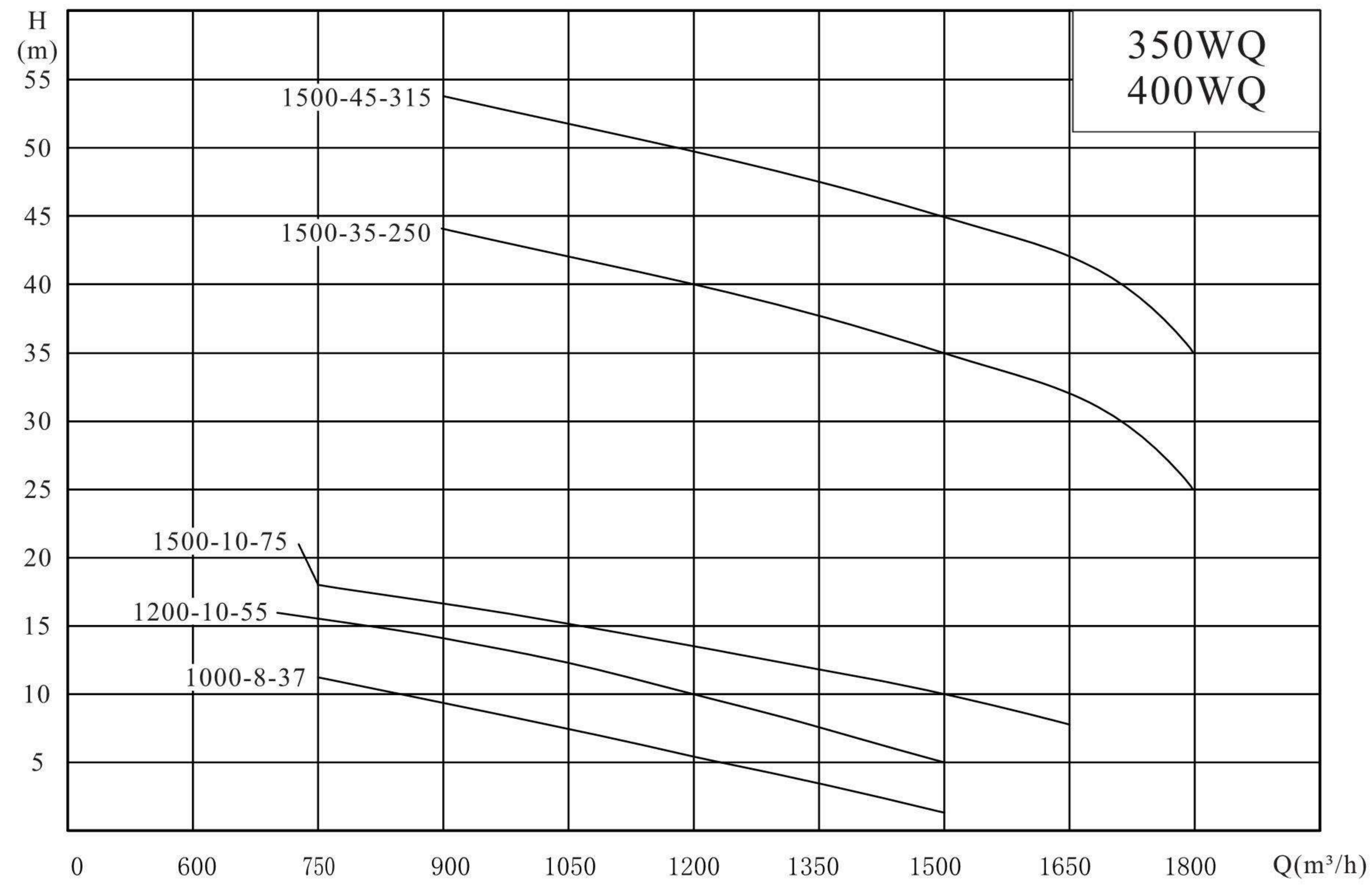

十八、Scope of supply, relevant dimensions

1、Scope of supply

Installation mode	Package of supplies	Optional parts	spare parts
Movable hose mounting	Main pump hose connector	hose	impeller Sealing ring bearing M/S
Movable hard tube installation	Main pump flange plate	Double flanged elbow	
Automatic coupling installation	Main pump automatic coupling device	Guide bar Anchor bolt Expansion bolt	

★ The electric control cabinet must have an electric control cabinet of the control system that matches the water leakage and thermal protection components inside the main pump to ensure the reliable and safe operation of the main pump. The electric control cabinet of sewage pump is specially developed for WQ series sewage pump, which can effectively protect the safe operation of main pump and realize automatic control.

2、Cast iron automatic coupling installation related dimensions and movable installation hose size unit: mm(except inch)

Items	Pump dia	50	65	80	100	150	200	250	300	350	400	500
Guide tube dimensions Water pipe/seamless steel pipe		1"/32×3		1.5"/48×3				2"/60×3			2.5"/76×4	
Guide tube length mm		Pool depth-30			-300	-350	-400	-500	-600	-700	Pool depth-850	
Specification and quantity of expansion bolts		M12×80×2			M14×100×2				M20×120×2			
Specification and quantity of anchor bolts		M16×250×4				M20×300×4				M24×350×4		
Dimensions of the holes reserved for anchor bolts		80×80×300				100×100×350				120×120×400		
Inner diameter of the hose		50	65	75	100	150	200	250	300	350	400	500

十九、Notice for order

1、the order should indicate the product model, name, performance parameters (flow, head)

Installation method, material and optional parts, spare parts, etc.

The selection should take into account the influence of the medium weight on the power and the influence and requirements of the medium corrosion and corrosion resistance on the pump flow seals. Welcome to consult and contact our technicians.

2、Inside pump of the safety protection (oil and water probe, water probe, thermal sensor) and other special requirements, must be indicated when ordering. When ordering the electric control cabinet, the control mode (control pump number and level control, etc.) and automation requirements should be indicated

3、the normal cable length of the submersible sewage pump is 8m, if it needs to be increased, Please advise.

4、Due to the excellent design of the guide rod frame in the coupling device, the guide rod only needs to be a general water pipe or steel pipe. In the sample, we have provided the specifications and length calculation method of the water pipe or steel pipe used as the guide rod. Users only need to purchase the water pipe or steel pipe by themselves and cut it to the required length. Therefore, the guide rod is not included in the coupling device. Guide bars are optional.

5、complete sets of supplies are provided according to the installation method selected by the user, optional parts and spare parts should be extra ordered by the customer.

二十、Product overview

The pump control system is the special control part of the automatic water supply and drainage equipment of our company. In order to cooperate with the reliable operation of the pump, NYK and NYB automatic control cabinets can be divided into liquid level control, pressure (constant pressure) control, time control, temperature control, air conditioning joint control, fire protection and other types according to the different needs of users, and have the main circuit short circuit, phase loss, overload, overcurrent and other protection functions.

二十一、Model definition

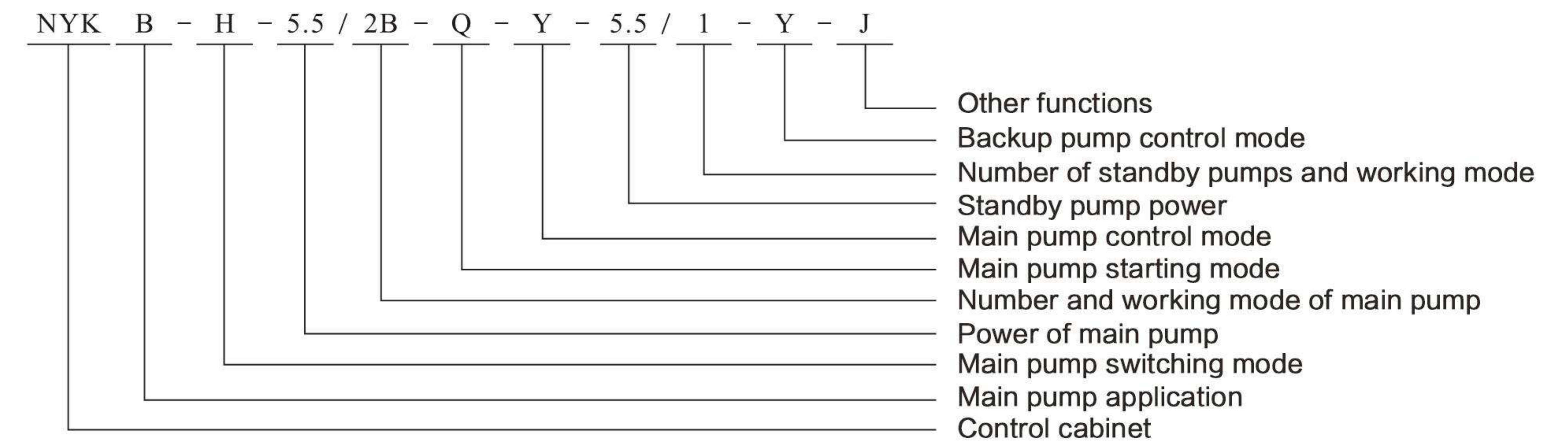

二十二、Model description

Item	Code	Meaning	Item	Code	Meaning	Item	Code	Meaning
control panel	NYK	Relay type control cabinet	Number of control pumps and working mode	1	1 working pump	control mode	Y	Level control
	NYB	Variable frequency speed control cabinet		2	2 working pumps		P	Pressure control
Applications	P	Water supply for industry and domestic		3	3 working pumps		T	Temperature control
	B	For submersible sewage pumps		4	4 working pumps		S	Timing control
	X	Fire, spray pump	2B	1work+1 standby	R		Man-machine interface control	
	C	Air conditioning, circulating water pump	3B	2works+1 standby	YC		Remote interface	
Switching mode	H	Manual alternate switching	4B	3works+1 standby	X		Fire sprinkler inspection	
	AC	Automatic alternate switching	Starting mode	Q	Direct starting		C	Air conditioning pump control
	AS	Timing automatic switching		Y	Star delta depressurization start		H	Life and fire separate use
				Z	Autobuck starting	E	Special control mode	
		R		Electronic soft start	J	Alarm function		
			B	Variable frequency starting	Functions			

二十三、Functions

1、Control type

(一) ordinary relay control: the AC contactor controls the start and stop of the pump motor, and the pump motor is in the power frequency full speed working state.

(二) NYB- Frequency conversion speed control: According to the instantaneous change of a certain parameter of the system (pressure, pressure difference, temperature, flow, etc.), the AC frequency conversion governor carries out stepless speed regulation on the pump motor to achieve the purpose of energy saving.

2、main and standby pump switching mode:

(一) H-manual switch: manually switch the main pump and standby pump. In case of failure of the primary pump, the standby pump will be automatically put into operation.

(二) AC- automatic alternating switching: suitable for the main pump, standby pump need to alternate work occasions, each start, the main and standby pump alternate once. When automatic alternation is not required, the switch can be changed to manual switching mode to select. This type can also have the function of backup pump failure (indicate when ordering);

(三) AS-timing automatic switching: suitable for the occasions when the main pump and the standby pump need to rotate regularly. When the main pump works to the set period, the timer automatically stops the main pump and starts the standby pump to balance the working time of the main and standby pumps. Choose the main pump and standby pump, manually switch. This function is the basic function of frequency conversion speed control.

3、Working mode of the pump

(一)、1 work+1 standby:

Control 1#, 2# two pumps, automatic can work in "1# with 2# standby" or "2# with 1# standby" two states, when the main pump fails, the standby pump will automatically put into work, "manual" start with the panel button operation control. If the user requires to increase the "dual-use" working mode (that is, two pumps can be used at the same time), you need to specify when ordering.

(二)、two use one standby:

Control 1#, 2#, 3# three pumps, can work in "1#, 2# with 3# standby" or "1#, 3# with 2# standby" or "2#, 3# with 1# standby" three states, when the main pump fails, the backup pump will automatically put into work. "Manual" start with the panel button operation control. If a main pump is turned off, it can be "one use and one standby". If the user requires to increase the "three-use" working mode [that is, three pumps can be used at the same time], please specify in detail when ordering.

(三)、3 workings+ 1 standby

Control of 1 #, 2 #, 3 #, 4 # 4 pumps, it can work in "1 #, 2 #, 3 # 4 # prepared" or "2 #, 3 #, 4 # 1 # prepared" or "1#, 3#, 4# with 2# standby" or "1#, 2#, 4# with 3# standby" four states, when the main pump fails, the backup pump will automatically put into work. "Manual" start with the panel button operation control. If a main pump is turned off, it becomes "dual use and standby"; If the two main pumps are turned off, it becomes "one use and one standby", if the user requires to increase the "four use" working mode (that is, four pumps can be used at the same time), you need to specify when ordering.

4、Starting mode:

(一)、R-direct starting: full voltage starting, full voltage operation, starting current is large;

(二)、Y-star triangle step-down starting: the motor stator winding is connected to the "Y" shape when starting, to reduce the voltage and current borne by each phase winding, and the motor stator winding is "Δ" shape when running;

(三)、Z-autotransformer step-down starting: when starting, reduce voltage and current by autotransformer step-down, and restore to full voltage during operation;

(四)、R-soft start: by the electronic soft starter buck start, starting process without contact switching, voltage and current rise smoothly, will not cause a big impact on the power grid and pipe network.

二十四、Control mode

1、Y-liquid level control: the pump to the liquid level as the control target, ordinary relay control according to the level of a water container (water tank, water tower, etc.) to control the start and stop of the pump; Frequency conversion speed control according to the level of a water container (water tank, water tower, etc.) to adjust the speed of the pump motor or control the start and stop of the pump;

2、P-pressure control: pump pressure as the control target, ordinary relay control according to the pressure of the pipe network to control the start and stop of the pump; Frequency conversion speed control according to the pressure of the pipe network to adjust the speed of the pump motor or control the start and stop of the pump to achieve the purpose of stabilizing the pipe network pressure;

3、E-special control mode: the pump takes other parameters as the control target, such as temperature, pressure difference, temperature difference, etc., the control process is the same as above.

二十五、Other functions

1、Yc-remote interface: The electric control cabinet is equipped with remote monitoring terminal, which can transmit the working condition of the pump to the distant duty room for monitoring;

2、control cabinet is equipped with dual power input interface; dual power supply can be automatically and manually switched;

3、I-man-machine interface: The electric control cabinet is equipped with a touch programmable terminal, which sets the working parameters of the system through an animated mimicry diagram and displays the operating reality of the equipment

4、S-special design: non-standard electric control cabinet, special design according to customer requirements